



**TEST REPORT  
IEC 60255-27  
Measuring relays and protection equipment –  
Part 27: Product safety requirements**

**Report Number**.....: 6042101.51

**Date of issue** .....: 2019-04-18

**Total number of pages**..... 76 pages

**Name of Testing Laboratory preparing the Report**.....: DEKRA Testing and Certification (Shanghai) Ltd.

**Applicant's name** .....: Shenzhen SOFAR SOLAR Co., Ltd.

**Address** .....: 401, Building 4, AnTongDa Industrial Park, District 68, XingDong Community, XinAn Street, BaoAn District, Shenzhen, China.

**Test specification:**

**Standard**.....: IEC 60255-27:2013 (Second Edition)

**Test procedure**.....: Type test

**Non-standard test method**.....: N/A

**Test Report Form No.** .....: IEC60255\_27A

**Test Report Form(s) Originator** ....: IMQ S.p.A.

**Master TRF** .....: 2014-09

**Copyright © 2014 IEC System of Conformity Assessment Schemes for Electrotechnical Equipment and Components (IECEE System). All rights reserved.**

This publication may be reproduced in whole or in part for non-commercial purposes as long as the IECEE is acknowledged as copyright owner and source of the material. IECEE takes no responsibility for and will not assume liability for damages resulting from the reader's interpretation of the reproduced material due to its placement and context.



If this Test Report Form is used by non-IECEE members, the IECEE/IEC logo and the reference to the CB Scheme procedure shall be removed.

**This report is not valid as a CB Test Report unless signed by an approved CB Testing Laboratory and appended to a CB Test Certificate issued by an NCB in accordance with IECEE 02.**

**General disclaimer:**

The test results presented in this report relate only to the object tested.

This report shall not be reproduced, except in full, without the written approval of the Issuing CB Testing Laboratory. The authenticity of this Test Report and its contents can be verified by contacting the NCB, responsible for this Test Report.

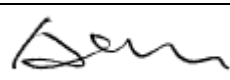
<b>Test item description</b> ..... :	Grid-connected PV Inverter	
<b>Trade Mark</b> ..... :		
<b>Manufacturer</b> ..... :	Shenzhen SOFAR SOLAR Co., Ltd. 401, Building 4, AnTongDa Industrial Park, District 68, XingDong Community, XinAn Street, BaoAn District, Shenzhen, China.	
<b>Model/Type reference</b> ..... :	SOFAR 10000TL-Sx Series, SOFAR 15000TL-Sx Series, SOFAR 17000TL-Sx Series, SOFAR 20000TL-Sx Series	
<b>Ratings</b> ..... :	<p>SOFAR 10000TL-Sx Series: PV input: Max.1000 Vdc, MPPT voltage range: 250-960 Vdc, max 15/15 A, Isc PV: 20/20 A Output: 400Vac, 3/N/PE, 50/60 Hz, max 10000 VA, max 3x15 A</p> <p>SOFAR 15000TL-Sx Series: PV input: Max.1000 Vdc, MPPT voltage range: 250-960 Vdc, max 21/21 A, Isc PV: 27/27 A Output: 400Vac, 3/N/PE, 50/60 Hz, max 15000 VA, max 3x22 A</p> <p>SOFAR 17000TL-Sx Series: PV input: Max.1000 Vdc, MPPT voltage range: 250-960 Vdc, max 21/21 A, Isc PV: 27/27 A Output: 400Vac, 3/N/PE, 50/60 Hz, max 17000 VA, max 3x25 A</p> <p>SOFAR 20000TL-Sx Series: PV input: Max.1000 Vdc, MPPT voltage range: 250-960 Vdc, max 24/24 A, Isc PV: 30/30 A Output: 400Vac, 3/N/PE, 50/60 Hz, max 20000 VA, max 3x29 A</p>	
<b>Responsible Testing Laboratory (as applicable), testing procedure and testing location(s):</b>		
<input checked="" type="checkbox"/>	<b>Testing Laboratory:</b>	DEKRA Testing and Certification (Shanghai) Ltd.
	<b>Testing location/ address</b> ..... :	3F, #250 Jiangchangsan Road, Building 16, Headquarter Economy Park Shibe Hi-Tech Park, Zhabei District, Shanghai 200436, China
<input checked="" type="checkbox"/>	<b>Associated Testing Laboratory:</b>	Suzhou Longce Testing Technology Service Co., Ltd.
	<b>Testing location/ address</b> ..... :	Building 5, No.369, Lushan Road, New District, Suzhou, China
	<b>Tested by (name, function, signature) :</b>	Jason Guo 
	<b>Approved by (name, function, signature) :</b>	Allan Chen 
<input type="checkbox"/>	<b>Testing procedure: TMP/CTF Stage 1:</b>	
	<b>Testing location/ address</b> ..... :	
	<b>Tested by (name, function, signature) :</b>	
	<b>Approved by (name, function, signature) :</b>	

<input type="checkbox"/>	<b>Testing procedure: WMT/CTF Stage 2:</b>		
<b>Testing location/ address..... :</b>			
<b>Tested by (name + signature) ..... :</b>			
<b>Witnessed by (name, function, signature) ..... :</b>			
<b>Approved by (name, function, signature):</b>			
<input type="checkbox"/>	<b>Testing procedure: SMT/CTF Stage 3 or 4:</b>		
<b>Testing location/ address..... :</b>			
<b>Tested by (name, function, signature) ..... :</b>			
<b>Witnessed by (name, function, signature) ..... :</b>			
<b>Approved by (name, function, signature):</b>			
<b>Supervised by (name, function, signature) ..... :</b>			

<b>List of Attachments (including a total number of pages in each attachment):</b>	
Attachment 1: Vibration, Shock, Bump, Seismic test report (21 pages) Attachment 2: Pictures (8 pages)	
<b>Summary of testing:</b>	
<b>Tests performed (name of test and test clause):</b> All applicable clauses test according standards IEC 60255-27:2013 were performed DEKRA Testing and Certification (Shanghai) Ltd. except below tests was performed in Suzhou Longce Testing Technology Service Co., Ltd.: 10.6.2.1 Vibration 10.6.2.2 Shock 10.6.2.3 Bump 10.6.2.4 Seismic	<b>Testing location:</b> DEKRA Testing and Certification (Shanghai) Ltd. 3F, #250 Jiangchangsan Road, Building 16, Headquarter Economy Park Shibe Hi-Tech Park, Zhabei District, Shanghai 200436, China  Suzhou Longce Testing Technology Service Co., Ltd. Building 5, No.369, Lushan Road, New District, Suzhou, China
<b>Summary of compliance with National Differences:</b>	
<b>List of countries addressed</b>	
N/A	
<input checked="" type="checkbox"/> <b>The product fulfils the requirements of IEC 60255-27:2013 (Second Edition)</b>	

**Copy of marking plate:**

**The artwork below may be only a draft. The use of certification marks on a product must be authorized by the respective NCBs that own these marks.**

**SOFAR SOLAR** Solar Grid-tied Inverter

Model No: SOFAR 10000TL-Sx Series

Max.DC Input Voltage	1000V
Operating MPPT Voltage Range	250~960V
Max. Input Current	2x15A
Max. PV Isc	2x20A
Nominal Grid Voltage	3/N/PE,230/400V~
Max. Output Current	3x15A
Nominal Grid Frequency	50/60Hz
Max. Output Power	10000VA
Power Factor	>0.99(adjustable+/-0.8)
Ingress Protection	IP65
Operating Temperature Range	-25°C~+60°C
Protective Calss	Class I
Made in China	

Manufacturer : Shenzhen SOFAR SOLAR Co.,Ltd.  
 Address : 401, Building 4, AnTongDa Industrial Park,  
 District 68, XingDong Community,XinAn Street,  
 BaoAn District, Shenzhen, China  
 SAA161911  
 VDE0126-1-1,VDE-AR-N4105,G83/2,EN50438,  
 C10/11,RD1699,UTE C15-712-1,AS4777

**SOFAR SOLAR** Solar Grid-tied Inverter

Model No: SOFAR 15000TL-Sx Series

Max.DC Input Voltage	1000V
Operating MPPT Voltage Range	250~960V
Max. Input Current	2x21A
Max. PV Isc	2x27A
Nominal Grid Voltage	3/N/PE,230/400V~
Max. Output Current	3x22A
Nominal Grid Frequency	50/60Hz
Max. Output Power	15000VA
Power Factor	>0.99(adjustable+/-0.8)
Ingress Protection	IP65
Operating Temperature Range	-25°C~+60°C
Protective Calss	Class I
Made in China	

Manufacturer : Shenzhen SOFAR SOLAR Co.,Ltd.  
 Address : 401, Building 4, AnTongDa Industrial Park,  
 District 68, XingDong Community,XinAn Street,  
 BaoAn District, Shenzhen, China  
 SAA161911  
 VDE0126-1-1,VDE-AR-N4105,G59/3,IEC61727,  
 IEC62116,C10/11,RD1699,UTE C15-712-1,AS4777

**SOFAR SOLAR** Solar Grid-tied Inverter

Model No: SOFAR 17000TL-Sx Series

Max.DC Input Voltage	1000V
Operating MPPT Voltage Range	250~960V
Max. Input Current	2x21A
Max. PV Isc	2x27A
Nominal Grid Voltage	3/N/PE,230/400V~
Max. Output Current	3x25A
Nominal Grid Frequency	50Hz
Max. Output Power	17000VA
Power Factor	>0.99(adjustable+/-0.8)
Ingress Protection	IP65
Operating Temperature Range	-25°C~+60°C
Protective Calss	Class I
Made in China	

Manufacturer : Shenzhen SOFAR SOLAR Co.,Ltd.  
 Address : 401, Building 4, AnTongDa Industrial Park,  
 District 68, XingDong Community,XinAn Street,  
 BaoAn District, Shenzhen, China  
 SAA161911  
 VDE0126-1-1,VDE-AR-N4105,G59/3,IEC61727,  
 IEC62116,C10/11,RD1699,UTE C15-712-1,AS4777

**SOFAR SOLAR** Solar Grid-tied Inverter

Model No: SOFAR 20000TL-Sx Series

Max.DC Input Voltage	1000V
Operating MPPT Voltage Range	250~960V
Max. Input Current	2x24A
Max. PV Isc	2x30A
Nominal Grid Voltage	3/N/PE,230/400V~
Max. Output Current	3x29A
Nominal Grid Frequency	50/60Hz
Max. Output Power	20000VA
Power Factor	>0.99(adjustable+/-0.8)
Ingress Protection	IP65
Operating Temperature Range	-25°C~+60°C
Protective Calss	Class I
Made in China	

Manufacturer : Shenzhen SOFAR SOLAR Co.,Ltd.  
 Address : 401, Building 4, AnTongDa Industrial Park,  
 District 68, XingDong Community,XinAn Street,  
 BaoAn District, Shenzhen, China  
 SAA161911  
 VDE0126-1-1,VDE-AR-N4105,G59/3,IEC61727,  
 IEC62116,C10/11,RD1699,UTE C15-712-1,AS4777

<b>Test item particulars</b> .....	Grid-connected PV Inverter
<b>Classification of installation and use</b> .....	Fixed
<b>Supply Connection</b> .....	Permanent connection
<b>External operating temperature range</b> .....	-25 to 60 ° C
<b>Altitude during operation (m)</b> .....	2000m
<b>Supply fluctuations</b> .....	According to the specified supply range
<b>Over voltage category (OVC) Mains</b> .....	<input type="checkbox"/> OVC I <input type="checkbox"/> OVC II <input checked="" type="checkbox"/> OVC III <input type="checkbox"/> OVC IV <input type="checkbox"/> other:
<b>Over voltage category (OVC) PV</b> .....	<input type="checkbox"/> OVC I <input checked="" type="checkbox"/> OVC II <input type="checkbox"/> OVC III <input type="checkbox"/> OVC IV <input type="checkbox"/> other:
<b>External pollution degree (PD)</b> .....	<input type="checkbox"/> PD 1 <input type="checkbox"/> PD 2 <input checked="" type="checkbox"/> PD 3
<b>Class of equipment</b> .....	<input checked="" type="checkbox"/> Class I <input type="checkbox"/> Class II <input type="checkbox"/> Class III <input type="checkbox"/> Not classified
<b>Possible test case verdicts:</b>	
- test case does not apply to the test object .....	<b>N/A</b>
- test object does meet the requirement.....	<b>P (Pass)</b>
- test object does not meet the requirement .....	<b>F (Fail)</b>
<b>Testing</b> .....	
<b>Date of receipt of test item</b> .....	2018-10-15 (samples provided by applicant)
<b>Date (s) of performance of tests</b> .....	2018-10-15 to 2019-04-02
<b>General remarks:</b>	
<p>"(See Enclosure #)" refers to additional information appended to the report.  "(See appended table)" refers to a table appended to the report.  The test results presented in this report relate only to the object tested.  This report shall not be reproduced, except in full, without the written approval of the Issuing testing laboratory.  This report is only for reference and is not used for legal proof function in China market.  The measurement result is considered in conformance with the requirement if it is within the prescribed limit, It is not necessary to account the uncertainty associated with the measurement result.  Throughout this report a <input type="checkbox"/> comma / <input checked="" type="checkbox"/> point is used as the decimal separator.</p>	
<b>Manufacturer's Declaration per sub-clause 4.2.5 of IEC 60384-14:</b>	
<b>The application for obtaining a CB Test Certificate includes more than one factory location and a declaration from the Manufacturer stating that the sample(s) submitted for evaluation is (are) representative of the products from each factory has been provided</b> .....	<input type="checkbox"/> Yes <input checked="" type="checkbox"/> Not applicable
<b>When differences exist; they shall be identified in the General product information section.</b>	
<b>Name and address of factory (ies)</b> .....	Dongguan SOFAR SOLAR Co., Ltd. 1F - 6F, Building E, No. 1 JinQi Road, Bihu Industrial Park, Wulian Village, Fenggang Town, Dongguan City, China.

**General product information:**

Breif description:

Product covered by this report is grid-connected PV inverter for indoor or outdoor installation. The connection to the DC input and AC output are through connectors. The structure of the unit complied with the IP 65 requirement.

The inverters intended to operate at ambient temperature -25 °C to +60 °C and 250-960 Vdc input, which will be specified in the user manual, The inverters will output full power when operated at 45 °C. If operated at higher than 45 °C temperature, the output power derating.

For all models, if the DC input voltage is higher than 850 Vdc the output power will be derating.

For model Sofar 20000TL-Sx, if the DC input voltage is lower than 430 Vdc, the output power will be derating.  
 For model Sofar 17000TL-Sx, if the DC input voltage is lower than 420 Vdc, the output power will be derating.  
 For model Sofar 15000TL-Sx, if the DC input voltage is lower than 370 Vdc, the the output power will be derating.  
 For model Sofar 10000TL-Sx, if the DC input voltage is lower than 350 Vdc, the output power will be derating.

For all models, if the AC output phase to phase voltage is lower than 230 Vac the output current will be limited to not higher than rated output current.

**SOFAR 10-20KW Block Diagram**

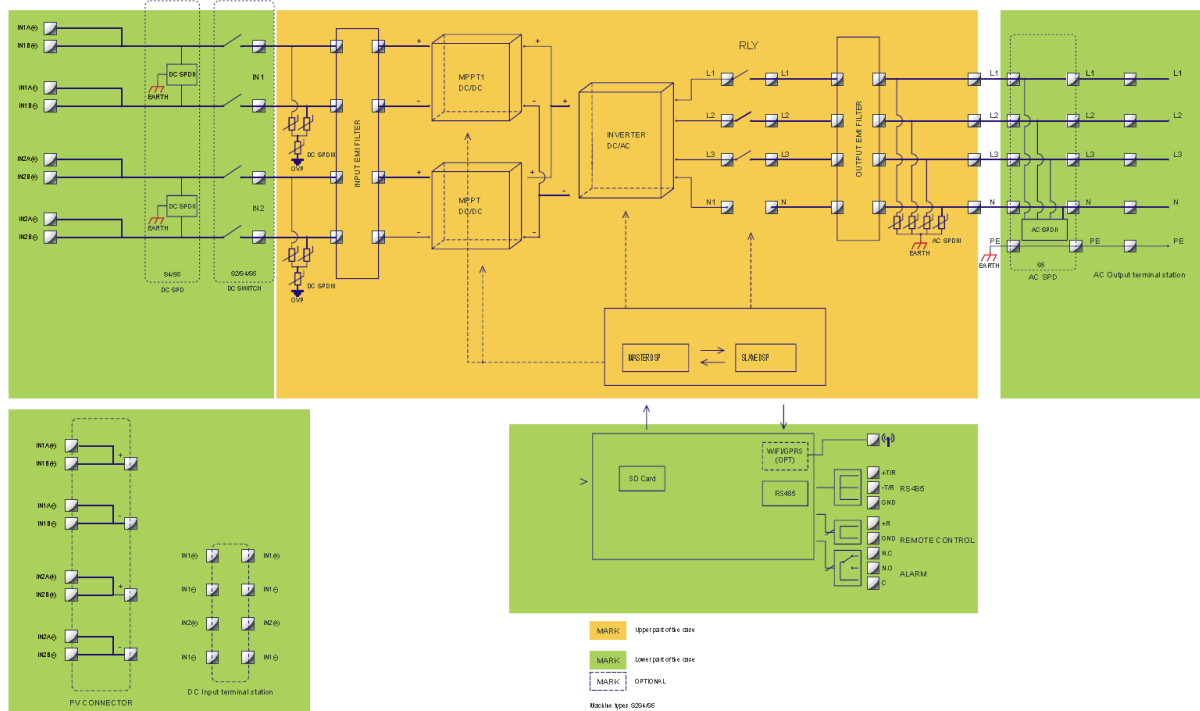

The product was tested on:

Hardware version: V1.00  
 Software version: V4.10

**Model difference:**

All the models have identical mechanical and electrical construction except some components and some parameter of the software architecture in order to control the max output power. And refer to the following table for detail.

Model	DC Cable Gland	PV connector	DC inside connector	Fuse PCB+ String detection board	DC surge arrester	DC switch	AC switch	AC surge arrester
Sofar 10000TL-S0 Sofar 15000TL-S0 Sofar 17000TL-S0 Sofar 20000TL-S0	√		√					
Sofar 10000TL-S1 Sofar 15000TL-S1 Sofar 17000TL-S1 Sofar 20000TL-S1	√		√			√		
Sofar 10000TL-S2 Sofar 15000TL-S2 Sofar 17000TL-S2 Sofar 20000TL-S2		√	√			√		
Sofar 10000TL-S3 Sofar 15000TL-S3 Sofar 17000TL-S3 Sofar 20000TL-S3		√		√		√		
Sofar 10000TL-S4 Sofar 15000TL-S4 Sofar 17000TL-S4 Sofar 20000TL-S4		√		√	√	√		
Sofar 10000TL-S5 Sofar 15000TL-S5 Sofar 17000TL-S5 Sofar 20000TL-S5		√		√	√	√		√
Sofar 10000TL-S6 Sofar 15000TL-S6 Sofar 17000TL-S6 Sofar 20000TL-S6		√		√	√	√	√	√

√ denotes incorporating this component.

#### Model list:

	Sofar 20000TL-Sx	Sofar 17000TL-Sx	Sofar 15000TL-Sx	Sofar 10000TL-Sx
PV connector (pair)	3x2	3x2	2x2	2x2
Boost chock	1800 μH	2100 μH	2100 μH	3000 μH
Boost IGBT (Q19, Q20, Q28, Q29)	2x2 parallel	2x2 parallel	2x2 parallel	2x1
Boost diode (D19, D20, D24, D25)	2x2 parallel	2x2 parallel	2x2 parallel	2x1
Input current sampling resistor (REA79, REA71, REA81, REA73)	15 kΩ	15 kΩ	15 kΩ	10 kΩ
Bus capacitor (CD1, CD2, CD3, CD4, CD5, CD6, CD7, CD8, CD39, CD40)	10 units	8 units	6 units	4 units



Boost capacitor (CA129, CA131, CA145, CA148)	4 units	4 units	3 units	2 units
Inverter chock	730 $\mu$ H	850 $\mu$ H	960 $\mu$ H	1460 $\mu$ H
IGBT module (QD1, QD2, QD3)	10- FZ12NMA080S HO 1-M260F  DS_F3L80R12 W1 H3_B11	10- FZ12NMA080S HO 1-M260F  DS_F3L80R12 W1 H3_B11	10- FZ12NMA080S HO 1-M260F  DS_F3L80R12 W1 H3_B11  10- FZ12NMA040S H- M267F	10- FZ12NMA080S HO 1-M260F  DS_F3L80R12 W1 H3_B11  10- FZ12NMA040 SH- M267F
Input current sampling resistor (RB46, RB52, RB79, RB81, RB95, RB58)	2.7 k $\Omega$	2.7 k $\Omega$	2.7 k $\Omega$	1.5 k $\Omega$

Other than special notice, the model Sofar 20000TL-S6 is as the representative test model in this report.

IEC 60255-27			
Clause	Requirement + Test	Result - Remark	Verdict

<b>4</b>	<b>General safety requirements</b>		-
4.1	General		P
4.2	Earthing requirements		P

<b>5</b>	<b>Protection against electric shock</b>		-
5.1	General		P
5.1.1	Introductory remark		P
5.1.2	Protection from contact with hazardous live parts		P
5.1.2.1	General		P
5.1.2.2	Insulation		P
5.1.2.3	Equipment case and barriers	IP65 enclosure and no opening in the case.	P
	Hazardous live parts	Hazardous live parts were separated from the accessible part.	P
	Top surfaces of barriers accessible in normal use...	No opening of EUT and the cover only can be removed with tool by trained personnel.	P
	Protection in service access areas		P
	- with rigid test finger and a force of 10 N		N/A
	- with jointed test finger		N/A
5.1.2.4	Hazardous live terminations using stranded wire		P
5.1.3	Discharge of capacitors		-
	Compliance checked by calculation		P
	Measured voltage (V); time-constant (s)		P
	Residual charge ( $\mu\text{C}$ )		P
5.1.4	Protective impedance	No protective impedance used.	-
	Requirements of 5.1.5.3.2 in normal and to level of 5.2.4.1.2 in single fault condition		N/A
	The protective impedance consists of one or more of the following:		N/A
	appropriate high-integrity single component		N/A
	combination of components		N/A
	combination of basic insulation and a current- or voltage-limiting device		N/A
	Voltage test for double/reinforced insulation		N/A

IEC 60255-27			
Clause	Requirement + Test	Result - Remark	Verdict
	Components and associated basic insulation checked after a single-fault condition assessment or test according to 10.6.5.5.		N/A
	Clearance, creepage distance between terminations of the impedance meet requirements of double or reinforced insulation of Annex C of this standard and 6.7 of IEC 61010-1:2010:		N/A
5.1.5	Accessible parts		-
5.1.5.1	General	All accessible metal parts were earthed and separated from live parts by basic insulation. All external accessible circuit were separated from live parts by reinforce insulation.	P
5.1.5.2	Determination of accessible parts		-
5.1.5.2.1	General		P
	Normal operational use, with or without the aid of a tool which will increase the accessibility	See 5.1.5.2.2 to 5.1.5.2.4 or test by inspection	P
5.1.5.2.2	General examination	No opening of EUT and the cover only can be removed with tool by trained personnel.	-
	Test with jointed test finger		N/A
	Test with rigid test finger (force of 10 N)		N/A
5.1.5.2.3	Openings above parts, enclosed by the case, which are hazardous live	No opening of EUT and the cover only can be removed with tool by trained personnel.	-
	Test with test pin (100mm, Ø4mm)		N/A
5.1.5.2.4	Openings for pre-set controls	No opening of EUT and the cover only can be removed with tool by trained personnel.	-
	Test with test pin (100mm, Ø3mm)		N/A
5.1.5.2.5	ELV rated or live parts accessible when cover removed		-
	Removing the cover without tools	No opening of EUT and the cover only can be removed with tool by trained personnel.	N/A
	- Symbol 14		N/A
	- Symbol 12		N/A
5.1.5.2.6	Wiring terminals		-
	IP1X according to 5.1 of IEC 60529		P
	- Symbol 12		P
5.1.1.3	Permissible limits for accessible parts		-

IEC 60255-27			
Clause	Requirement + Test	Result - Remark	Verdict
5.1.5.3.1	General		P
	Values of 5.1.5.3.2 in normal operational condition and nor those of 5.2.4.1.2 in single-fault condition.		P
5.1.5.3.2	Values under normal conditions		-
	a) Voltage limits less than 33 V r.m.s. or 70 V d.c. :		P
	for wet locations voltage limits less than 25 V r.m.s. or 37.5V d.c.	Communication port was accessible conductive part that voltage less than 25 V r.m.s. or 37.5 V d.c.	P
	Voltages are not hazardous live the levels of	Communication port.	P
	b) Current less than 0,5 mA r.m.s. for sinusoidal, 0,7 mA peak non-sinusoidal or mixed frequencies or 2 mA d.c. when measured with measuring circuit A.1 or A.2 if less than 100 Hz		N/A
	for wet locations measuring circuit A.4 used		N/A
	70 mA r.m.s. when measured with circuit A.3 for higher frequencies :		N/A
	c) Levels of capacitive charge or energy less:		N/A
	1) 45 $\mu$ C for voltages up to 15 kV peak or d.c. or line A of Figure 3 of IEC 61010-1:2010		N/A
	2) 350 mJ stored energy for voltages above 15 kV peak or d.c.		N/A
5.1.6	Bonding to the protective conductor		-
5.1.6.1	Insulation between live parts and accessible conductive parts		P
	Accessible conductive parts		P
	Unearthed accessible conductive parts		P
	separated from by double insulation or reinforced insulation, or		P
	Equipment of class I protection		P
5.1.6.2	Protective bonding		P
	Accessible conductive parts bonded, or		P
	EVL circuit protected in case of direct contact of 5.1.5		P
	magnetic cores are used		P
	parts of small dimensions separated from hazardous live parts by at least basic insulation		P
5.1.6.3	Bonding of parts connected to the protective conductor		P
5.1.6.4	Protection against corrosion		P

IEC 60255-27			
Clause	Requirement + Test	Result - Remark	Verdict
5.1.6.5	Interruption of protective bonding	No such protective bonding.	N/A
5.1.7	Protective conductor connection		P
	means of connection		P
	suitable for use		P
	not be used as a part of the mechanical assembly .:		P
5.1.8	High leakage current	Measured continuous leakage current was 2.54 mA, and the EUT was permanently connected equipment.	N/A
5.1.9	Solid insulation		-
5.1.9.1	General		P
5.1.9.2	Requirements	(see appended table 10.6.4.2/ 10.6.4.3)	P
5.1.10	Clearances and creepage distances		-
5.1.10.1	General		P
5.1.10.2	Clearances		P
5.1.10.2.1	General		P
5.1.10.2.2	Clearances for primary circuits	(see appended table 10.6.3)	P
5.1.10.2.3	Clearances for non-primary circuits	(see appended table 10.6.3)	P
5.1.10.2.4	Creepage distances:	(see appended table 10.6.3)	P
5.1.11	Functional earthing:		P
	Requirements:		P
	Connection to protective conductor terminal permitted:		P
	separated by a functional insulation:		P
	separated from parts at hazardous voltage by:		P
	1) double insulation or reinforced insulation : or		P
	2) a protectively earthed screen or another protectively earthed conductive part, separated from parts at hazardous voltages by at least basic insulation :		P
5.2	Single-fault conditions		-
5.2.1	Testing in single-fault condition	(see appended table 5.2)	P
	not risk of electric shock or fire after a single-fault test:		P
5.2.2	Application of single-fault condition		P
5.2.2.1	General:		P

IEC 60255-27			
Clause	Requirement + Test	Result - Remark	Verdict
5.2.2.2	Protective impedance:		N/A
5.2.2.3	Transformers:		P
5.2.2.4	Outputs:		P
5.2.2.5	Insulation between circuits and parts:		P
5.2.2.6	Primary circuits and hazardous voltage non-primary circuits:		P
5.2.2.7	Overloads:		P
5.2.2.8	Intermittently rated resistors:	No such resistors used.	N/A
5.2.2.9	DC inputs:		P
5.2.3	Duration of tests:	(see appended table 5.2)	P
5.2.4	Compliance		-
5.2.4.1	Compliance with requirements for electric shock protection		-
5.2.4.1.1	General:		P
5.2.4.1.2	Values in single-fault condition	(see appended table 5.2.4.1.2)	P
	a) Voltage limits less than 55 V r.m.s. or 140 V d.c. :		P
	For temporary voltages, limits less than 55 V r.m.s. and 78 V peak or 140 V d.c.		P
	for wet locations voltage limits less than 33V r.m.s. or 70d.c.	Communication port was accessible conductive part that voltage less than 33 V r.m.s. or 70 V d.c.	P
	b) Current less than 3,5 mA r.m.s. for sinusoidal, 5 mA peak non-sinusoidal or mixed frequencies or 15 mA d.c. when measured with measuring circuit A.1 or A.2 if less than 100 Hz or 500mA r.m.s (Figure with $R_B = 75 \Omega$ Relates to possible burns in the frequency range 30 kHz to 500 kHz)		N/A
	for wet locations measuring circuit A.4 used (with $R_S = 375 \Omega$ (instead of 1 500 $\Omega$ ) :		N/A
	Current less than 3,5 mA r.m.s. for sinusoidal, 5mA peak non-sinusoidal or mixed frequencies or 15 mA d.c		N/A
	c) capacitance level is that defined in Figure 3. curve B in IEC 61010-1:2010:		N/A
5.2.4.2	Compliance with requirements for temperature protection:		P

IEC 60255-27			
Clause	Requirement + Test	Result - Remark	Verdict
5.2.4.3	Compliance with requirements for protection against the spread of fire:		P
5.2.4.4	Compliance with requirements for hazardous gases and chemicals:		P
5.2.4.5	Compliance with requirements for mechanical protection		P

<b>6</b>	<b>Mechanical aspects</b>		-
6.1	Protection against mechanical hazards		-
6.1.1	Stability:		P
6.1.2	Moving parts:		P
6.1.3	Edges and corners:		P
6.2	Mechanical requirements		P
	Mechanical tests requirements of 10.6.2.1 to 10.6.2.4		P
	Higher severity levels:		N/A
6.3	Mechanical security of terminations	(see Annex E)	P

<b>7</b>	<b>Flammability and resistance to fire</b>		-
7.1	General		P
	reducing the risk of fire by one of the following means:		-
	Eliminating or reducing the sources of ignition within the equipment:		P
	Reducing the amount of combustible (or flammable) materials within the equipment:		P
	Containment of a fire within the equipment:		P
7.2	Rationale		P
	Risk of fire in normal and single fault condition:		P
	In order for a risk of fire within the equipment to exist, all three of the following basic elements shall exist:		P
	The equipment circuits shall have sufficient power or energy to be an ignition source		P
	There shall be oxygen present (air is about 21 % oxygen) :		P
	There shall be combustible materials present to support the combustion process:		P

IEC 60255-27			
Clause	Requirement + Test	Result - Remark	Verdict
	Conformity is checked by minimum one or a combination of the following (see Figure 1):		P
	Equipment temperature limits of 7.3.1:		P
	Single Fault test of 7.11 and 10.6.5.5:		P
	Minimization of fire risk and reducing sources of ignition of 7.4 and 7.4.2:		P
	Containment of a fire within equipment of 7.10:		P
7.3	General hazards from overheating and fire		-
7.3.1	Equipment temperature limits:		P
	In normal conditions:	(See appended table 7.3)	P
	In single-fault condition (limits of clause 7.11) :	(See appended table 5.2)	P
	Symbol 13 of Table 10:		P
	Symbol 14 of Table 10:		P
7.3.2	Hazardous gases and chemicals	No gases and chemicals used.	-
	Manufacturer's documentation:		N/A
7.4	Minimization of fire risk		-
7.4.1	General		P
	Critical components of primary circuits and circuits exceeding ELV voltage limits. Compliance with Annex D:		P
7.4.2	Eliminating or reducing the sources of ignition within the equipment		P
	a) Either 1) or 2)		P
	1) Limited-energy circuit as specified in 7.12		P
	2) Insulation between parts at different potentials, compliance with clause 7.11		P
	b) circuits designed to produce heat in compliance with clause 5.2:		N/A
	Circuits not classified as limited-energy circuits. Method i) or ii) below shall be used.		P
	i) Testing in the single-fault conditions in compliance with clause 5.2:		P
	ii) Verifying as in 7.11 that if a fire occurs it will be contained within the equipment:		P
7.5	Cabling and fusing		P
	Manufacturer's recommendations:		P
	Connection cables: minimum cross-section and voltage rating:		P



IEC 60255-27			
Clause	Requirement + Test	Result - Remark	Verdict
	Protection devices:		P
7.6	Flammability of materials and components		-
7.6.1	General:		P
	Conformity is checked by inspection:		P
	Tests in compliance with IEC 60695-11-10:		P
7.6.2	Materials for components and other parts inside fire enclosures:		P
7.6.3	Materials for fire enclosures:		P
7.6.4	Materials for components and other parts outside fire enclosures:		P
7.7	Fire ignition sources:		P
7.8	Conditions for a fire enclosure	Metal enclosure used.	-
7.8.1	General:		P
7.8.2	Parts requiring a fire enclosure:		P
7.8.3	Parts not requiring a fire enclosure:		P
7.9	Requirements for primary circuits and circuits exceeding ELV limits:		P
7.10	Fire enclosures and flame barriers		-
	Enclosure meets following requirements:	No opening in the metal enclosure.	P
	Bottom:		P
	no openings, or:		P
	to the extent in Figure 3, shall be constructed with baffles as specified in Figure 2, or:		N/A
	be made of metal, perforated as specified in Table 6, or:		N/A
	be a metal screen with a mesh not exceeding 2 mm x 2 mm centre to centre and a wire diameter of at least 0,45 mm :		N/A
	The sides shall have no openings within the area that is included within the inclined line C in Figure 3 or:		N/A
	Case and baffle or flame barrier:		N/A
7.11	Assessment of the fire risk due to a single-fault condition		-
7.11.1	Guidelines for maximum acceptable temperatures when subjecting a circuit or component to a single-fault condition		P
7.11.2	Temperature of windings under a normal condition or a single-fault condition	(See appended table 7.3 and 5.2 )	P

IEC 60255-27			
Clause	Requirement + Test	Result - Remark	Verdict
7.11.3	Compliance of equipment with requirements for protection against the spread of fire		P
7.12	Limited-energy circuit	Not applied.	N/A
	a) Potential not more than 33 r.m.s. or 70 V dc		N/A
	b) Current limited by one of following means:		N/A
	3) Inherently or by impedance (see Table 8); or		N/A
	4) Overcurrent protective device (see Table 9); or		N/A
	5) A regulating network limits also in single fault condition (see Table 8)		N/A
	c) Is separated by at least basic insulation		N/A
	Fuse or a nonadjustable electromechanical device is used		N/A

<b>8</b>	<b>General and fundamental design requirements for safety</b>		-
8.1	Climatic conditions for safety		P
	Environmental ranges declared by the manufacturer:		P
	temperature, operation and storage:		P
	humidity, non-condensing:		P
	atmospheric pressure:		P
8.2	Electrical connections		P
	electrical terminations and connection points:		P
	protective bonding:	(See appended table 10.6.4.5)	P
	wires and cables:		P
	Conductors:		P
	electrical connections:		P
8.3	Components		-
8.3.1	General	(See appended table 8.3)	P
8.3.2	High-integrity part or component		P
8.4	Connection to telecommunication networks Requirements according to IEC 62151:	Not connect to telecommunication networks	N/A
8.5	Connection to other equipment Requirements in accordance with Table A.1:		P
8.6	Laser sources Requirements in accordance with IEC 60825-1:	No such device.	N/A

IEC 60255-27			
Clause	Requirement + Test	Result - Remark	Verdict
8.7	Explosion		-
8.7.1	General:		P
8.7.2	Components at risk of explosion		-
8.7.2.1	General:	(see clause 5.2.4.5)	P
8.7.2.2	Batteries	No battery used	N/A
	Compliance with Annex F:		N/A
	Marking and warning:		N/A
	Rechargeable batteries:		N/A
	Battery compartment:		N/A
	Batteries intended to be replaced by the user:		N/A

<b>9</b>	<b>Marking, documentation and packaging</b>		-
9.1	Marking		-
9.1.1	General		P
	Removable parts:		P
	Symbols according to table 9:		P
	Rack or panel equipment:		P
	Voltages, currents, frequency and their tolerances according to IEC 60255-6:		P
9.1.2	Identification		-
	Equipment is identified on the equipment by:		P
	a) Manufacturer's or supplier's name or trademark		P
	b) Model or type reference:		P
	Manufacturing location identified:		P
9.1.3	Auxiliary supplies, VT, CT, I/O9	No such device.	-
9.1.3.1	General requirements for marking		-
	For marking the following should be taken into account:		N/A
	a) a.c. – with symbol 2 of Table 9 and rated frequency or frequency range:		N/A
	b) d.c. – with symbol 1 of Table 9 :		N/A
	c) symbol 3 of Table 9 on equipment for a.c. and d.c. supply:		N/A
	d) symbol 4 of Table 9 on equipment for 3 phase a.c. supply:		N/A

IEC 60255-27			
Clause	Requirement + Test	Result - Remark	Verdict
	e) a hyphen (-) shall be used to separate the lower and upper nominal voltages, for example, 125 V-230V:		N/A
	f) for measurands either a hyphen (-) or an ellipse (...) shall be used to separate the lower and upper voltages:		N/A
	g) for selectable voltage or current markings:		-
	the lower and upper selectable values shall be separated by means of a solidus, i.e. forward slash (/):		N/A
	voltages or frequencies where switching is automatic then the markings shall be according to symbol 15 of Table 9 or the word "AUTO":		N/A
	operating voltage achieved using an external, separate device, use +EXT.R.:		N/A
	h) the burden in watts (active power) or volt-amperes (apparent power) or the rated input current, with all accessories or plug-in modules connected:		N/A
	The documentation shall specify the burden:		N/A
	The measured value shall not exceed the marked value by more than 10 %:		N/A
	i) the rated supply voltage(s) or the rated supply voltage range:		N/A
	voltage range more than 20 % of the mean value:		N/A
	different rated supply voltages:		N/A
9.1.3.2	Auxiliary supply		-
	The following information shall be provided:		-
	a) on the equipment and in the documentation:		N/A
	a.c. and/or d.c. supply:		N/A
	the rated values:		N/A
	b) in the documentation:		N/A
	the burden:		N/A
9.1.3.3	Measurands		-
	The following information shall be provided:		N/A
	a) on the equipment and in the documentation:		N/A
	the nominal values, for example, voltage, current, frequency:		N/A
	b) in the documentation:		N/A
	the burden:		N/A

IEC 60255-27			
Clause	Requirement + Test	Result - Remark	Verdict
	the overload withstand:		N/A
9.1.3.4	Inputs		-
	The following information shall be provided in the documentation:		N/A
	a) a.c. and/or d.c. supply:		N/A
	b) the rated values:		N/A
	c) burden on the supply input:		N/A
9.1.3.5	Outputs		-
	The following information shall be provided in the documentation:		N/A
	a) the kind of output, for example, relay, optocoupler etc:		N/A
	b) burden on the supply input:		N/A
	c) the switching capability on/off:		N/A
	d) the switching voltage:		N/A
	e) the permissible current, continuous value and short time value for 1s:		N/A
	f) withstand voltage across open contacts:		N/A
9.1.4	Fuses	No such device used.	-
	Operator replaceable fuse marking:		N/A
	Not replaceable by the user:		N/A
9.1.5	Measuring circuit terminals		-
	Marking shall be adjacent to the measuring terminals:		N/A
	If insufficient space, symbol 14 used:		N/A
	Symbol 14 and/or 12 of Table 9:		N/A
	Voltage 33 V a.c. or 70 V d.c		N/A
	Exceptions:		N/A
9.1.6	Terminals and operating devices		-
	Safety markings:		P
	AC or d.c. supply:		P
	Operating device markings:		P
	Functional earth terminals:		N/A
	Protective conductor terminals:		P
	Marking place:		P
	Plug/socket device:		P

IEC 60255-27			
Clause	Requirement + Test	Result - Remark	Verdict
	Marking for accessible terminals:		P
	Marking for lasers or high-intensity infra-red diodes of class 2 rating or higher:		N/A
9.1.7	Equipment protected by double or reinforced insulation:		N/A
9.1.8	Batteries		-
9.1.8.1	Replaceable batteries:	No battery used.	N/A
	Battery accessible to the user:		N/A
	Battery not accessible to the user:		N/A
	Polarity of the battery:		N/A
9.1.8.2	Charging:		N/A
9.1.9	Test voltage marking:		N/A
9.1.10	Warning markings		-
	Rack- or panel-mounted equipment:	Wall mounted equipment.	P
	Access in normal use:		P
	Equipment documentation:		P
	Batteries:		N/A
	Warning markings size:		N/A
9.1.11	Marking durability:		P
9.2	Documentation		-
9.2.1	General:		P
	Explanation of warning symbols:		P
	Protective conductor connections:		P
	Equipment ratings, operating instructions and installation instructions:		P
	Information specified in 9.2.2 to 9.2.5:		P
	Intended use:		P
9.2.2	Equipment ratings	See rating label	-
9.2.2.1	General		P
	Oversvoltage category:	OVC III for MAINS; OVC II for PV	P
	Rated voltage(s) or voltage range(s) (V) :		P
	Rated frequency or rated frequency range (Hz) :		P
	Rated power (W) rated current (mA or A) :		P
	Nominal functional value:		P
	Input and output connections:		P

IEC 60255-27			
Clause	Requirement + Test	Result - Remark	Verdict
9.2.2.2	Fuses and external protective devices		-
	Fuse ratings:		N/A
	External device:	According to user manual the circuit breaker should use in final Installation.	P
9.2.2.3	Environmental requirement		-
	IP rating:	IP65	P
	Pollution degree:	PD2 (Inside); PD3 (Outside)	P
	Insulation class:	Class I	P
9.2.3	Equipment installation		-
	Safe mounting:		P
	Protective earthing		P
	Ventilation requirements:		P
	Digital input circuits and output relays:		N/A
	Wire:		P
	External devices:		P
9.2.4	Equipment commissioning and maintenance		-
	Fault-finding and repair:		P
	Equipment part:		P
	Safe methods for changing and disposal of:		-
	Accessible fuses:		N/A
	Replaceable batteries:		N/A
	Re-charging and/or replacement for re-chargeable batteries:		N/A
	Fibre-optic output devices:		N/A
9.2.5	Equipment operation		-
	Operating instructions:		-
	CT circuits:		N/A
	Responsibility of the user:		P
	pictures and symbols used:		P
9.3	Packaging		P

<b>10</b>	<b>Type tests and routine tests</b>		-
10.1	General:		P
10.2	Safety type tests:		P

IEC 60255-27			
Clause	Requirement + Test	Result - Remark	Verdict
10.3	Routine testing or sample testing:		N/A
10.4	Conditions for testing:	Considered.	P
10.5	Verification procedure:	Considered.	P
10.6	Tests		-
10.6.1	Climatic environmental tests		-
10.6.1.1	Dry-heat test – operational. Tests according to IEC 60255-1		P
10.6.1.2	Cold test – operational. Tests according to IEC 60255-1		P
10.6.1.3	Dry heat test at maximum storage temperature. Tests according to IEC 60255-1		P
10.6.1.4	Cold test at minimum storage temperature. Tests according to IEC 60255-1		P
10.6.1.5	Damp-heat test. Tests according to IEC 60255-1		P
10.6.1.6	Cyclic temperature with humidity test. Tests according to IEC 60255-1		P
10.6.2	Mechanical tests	See attachment 1: Vibration, Shock, Bump, Seismic test report	-
10.6.2.1	Vibration Tests according to IEC 60255-21-1		P
10.6.2.2	Shock Tests according to IEC 60255-21-2:		P
10.6.2.3	Bump Tests according to IEC 60255-21-2:		P
10.6.2.4	Seismic Tests according to IEC 60255-21-3:		P
10.6.2.5	Accessible parts test	(See clause 5.1.5)	P
10.6.2.6	Dust/water ingress protection Tests according to IEC 60529:	IP65	P
10.6.3	Clearances and creepage distances		-
	Compliance with Annex C:	(see appended table 10.6.3)	P
	Compliance with clause 5.1.10.2.2:	(see appended table 10.6.3)	P
	Transient suppressor used to reduce the overvoltage. Tests according to IEC 60255-26:		N/A
10.6.4	Safety-related electrical tests		-



IEC 60255-27			
Clause	Requirement + Test	Result - Remark	Verdict
10.6.4.1	General:		P
10.6.4.2	Impulse voltage test		-
10.6.4.2.1	General:		P
10.6.4.2.2	Test procedures:		P
10.6.4.2.3	Waveform and generator characteristics:		P
10.6.4.2.4	Selection of impulse test voltage:		P
10.6.4.2.4.1	General:		P
	Altitudes(m) :		P
10.6.4.2.4.2	Equipment to tested at 5 kV peak nominal		P
10.6.4.2.4.3	Equipment to tested at 1 kV peak nominal		N/A
	auxiliary (power supply) circuits:		P
	equipment power supply:		P
	I/O circuits:		P
10.6.4.2.5	Performing of tests		P
	test performed between the followings part:	(see appended table 10.6.4.2)	P
	between each circuit specified for the same impulse voltage:		P
	between independent circuits:		P
	across the terminals of a given circuit:		P
	Equipment with an insulated case:		P
10.6.4.2.6	Test acceptance criteria		-
	During the tests:		P
	After the tests:		P
10.6.4.2.7	Repetition of the impulse voltage test:		P
10.6.4.3	AC or d.c. dielectric voltage test		-
10.6.4.3.1	General:		P
10.6.4.3.2	Performing the dielectric voltage test:	(see appended table 10.6.4.3)	-
10.6.4.3.2.1	Type tests		-
	test performed between the followings part:		P
	between each circuit and the accessible conductive parts:		P
	between independent circuits:		P
	dielectric voltage withstand, for open metallic contacts:		P

IEC 60255-27			
Clause	Requirement + Test	Result - Remark	Verdict
10.6.4.3.2.2	Routine tests:		N/A
10.6.4.3.2.3	Routine tests by sampling:		N/A
10.6.4.3.3	Value of the dielectric test voltage:		P
10.6.4.3.4	Test voltage source:		P
10.6.4.3.5	Test method:		P
10.6.4.3.6	Test acceptance criteria:		P
10.6.4.3.7	Repetition of the dielectric voltage test:		P
10.6.4.4	Insulation resistance:	(See appended table 10.6.4.4)	P
10.6.4.5	Protective bonding tests	(See appended table 10.6.4.5)	P
10.6.5	Electrical environment and flammability		-
10.6.5.1	Maximum temperature of parts and materials:		P
10.6.5.2	Flammability of insulating materials, components and fire enclosures:		N/A
10.6.5.3	Thermal short-time test		-
	Overvoltage:		N/A
	Overcurrent:		N/A
10.6.5.4	Output relay parameters Parameters in according to IEC 60255-26:		N/A
10.6.5.5	Single-fault condition:		N/A
10.6.6	Reverse polarity and slow ramp test:	(See appended table 5.2)	P
<b>A</b>	<b>ANNEX A, ISOLATION CLASS REQUIREMENTS AND EXAMPLE DIAGRAMS (NORMATIVE) (see 5.1.2; 5.1.6.2; 5.1.10)</b>		<b>P</b>
<b>B</b>	<b>ANNEX B, RATED IMPULSE VOLTAGES (NORMATIVE) (see 5.1.2.2)</b>		<b>P</b>
<b>C</b>	<b>ANNEX C, GUIDANCE FOR THE DETERMINATION OF CLEARANCE, CREEPAGE DISTANCE AND WITHSTAND VOLTAGES (NORMATIVE) (see 5.1.2.2; 5.1.4; 5.1.10; 10.6.3)</b>		<b>P</b>
<b>D</b>	<b>ANNEX D, COMPONENTS (INFORMATIVE) (see 7.4.1; 8.3; 8.7.1)</b>		<b>P</b>
<b>E</b>	<b>ANNEX E, EXTERNAL WIRING TERMINATIONS (NORMATIVE) (see 6.3)</b>		<b>-</b>
E.1	General		P
E.2	Permanently connected equipment		P
	a) a set of terminals; or		P
	b) a non-detachable power supply cable.		N/A

IEC 60255-27			
Clause	Requirement + Test	Result - Remark	Verdict
	terminals:		P
	screws and nuts:		P
	power supply cables:		N/A
	a) two independent fixings:		N/A
	b) mechanical fixing of the cables:		N/A
E.3	Conductors		N/A
	Connection of conductors in compliance with Table E1. :		N/A
E.4	Terminals		P
	Contact pressure size in compliance with Table E2. :		P
	Terminals contact pressure:		P
	Slipping of the conductor:		P
	Terminals shall be so fixed that when the means of clamping the conductor is tightened or loosened:		P
	a) the terminal itself does not work loose:		P
	b) internal wiring is not subjected to stress:		P
	Ordinary non-detachable power supply cables:		N/A
	c) creepage distances and clearances are not reduced below the values specified in Annex C. :		P
<b>F</b>	<b>ANNEX F, EXAMPLES OF BATTERY PROTECTION (INFORMATIVE) (see 8.7.2.2)</b>		<b>N/A</b>

IEC 60255-27			
Clause	Requirement + Test	Result - Remark	Verdict

5.2	TABLE: Fault condition tests					P
Component No.	Fault	Supply voltage (V)	Test time	Fuse #	Fuse current (A)	Comments/ Observation
DC input	Re- verse polarity	Input: 850 Vdc Output: 230 Vac	1 min	--	--	Inverter did not work. No hazard.
CEA4 (for DC Current transducer)	S/C	Input: 850 Vdc Output: 230 Vac	10 min	--	--	The unit operated normally at beginning. LCD displayed error input current, after about 3 min. And the unit shut down and disconnected from the grid. Error message: "permanent".
CC1	S/C	Input: 850 Vdc Output: 230 Vac	5 min	--	--	The unit shut down and disconnected from the grid immediately. Error message: "ID11". No damaged and no hazards.
QA1 Pin D-S	S/C	Input: 850 Vdc Output: 230 Vac	5 min	--	--	The unit operated normally. No damaged and no hazards.
CA37	S/C	Input: 850 Vdc Output: 230 Vac	5 min	--	--	The unit operated normally. No damaged and no hazards.
DA18 pin 1-2	S/C	Input: 850 Vdc Output: 230 Vac	5 min	--	--	The unit shut down and disconnected from the grid immediately. Error message: "permanent". No damaged and no hazards.
DA19 Pin 1-2	S/C	Input: 500 Vdc Output: 230 Vac	1 s	--	--	Output breaker opened. The unit shut down and disconnected from the grid immediately. Component DA19, QA19, QA20, DA20 damaged. LCD no display. No hazards.
QA29 Pin C-G	S/C	Input: 500 Vdc Output: 230 Vac	1s	--	--	Output breaker opened. The unit shut down and disconnected from the grid immediately. Component QA29, QA28 damaged. LCD no display and no hazards.
QA19 Pin C-E	S/C	Input: 500 Vdc Output: 230 Vac	3 min	--	--	The unit shut down and disconnected from the grid immediately. LCD no display. No damaged and no hazards.

IEC 60255-27						
Clause	Requirement + Test				Result - Remark	Verdict
CA129	S/C	Input: 960 Vdc Output: 230 Vac	3 min	--	--	The unit shut down and disconnected from the grid immediately. Components QD1, QD2, QD3, DA19, DA20, QA19, QA20, DA24, DA25, QA28, and QA29 damaged. LCD no display. No hazards.
CD1	S/C	Input: 960 Vdc Output: 230 Vac	3 min	--	--	The unit shut down and disconnected from the grid immediately. Output breaker opened. Components QD2, QD3, QD1 damaged. Error message: "ID66, ID27, ID26, ID02, ID70". No hazards
CB25	S/C	Input: 500 Vdc Output: 230 Vac	5 min	--	--	The unit operated normally. No damage and no hazard.
CB44 (for AC current transducer)	S/C	Input: 500 Vdc Output: 230 Vac	3 min	--	--	The unit shut down and disconnected from the grid immediately. No damaged and no hazards.
DA11	S/C	Input: 850 Vdc Output: 230 Vac	5 min	--	--	The unit shut down and disconnected from the grid immediately. DC fan stopped. LCD no display. No damaged and no hazards.
DA13	S/C	Input: 850 Vdc Output: 230 Vac	5 min	--	--	The unit shut down and disconnected from the grid immediately. DC fan stop. LCD no display. No damaged and no hazards.
DA8	S/C	Input: 850 Vdc Output: 230 Vac	5 min	--	--	The unit shut down and disconnected from the grid immediately. LCD no display. No damaged and no hazards.
DA6	S/C	Input: 850 Vdc Output: 230 Vac	5 min	--	--	The unit shut down and disconnected from the grid immediately. LCD no display. No damaged and no hazards
QA5 D-G	S/C	Input: 850 Vdc Output: 230 Vac	5 min	--	--	The unit shut down and disconnected from the grid immediately. Components QA5, RA146, RA145, RA152, RA153, RA154, QA12, DA6 damaged. LCD no display. No hazards

IEC 60255-27						
Clause	Requirement + Test				Result - Remark	Verdict
QA5 D-S	S/C	Input: 850 Vdc Output: 230 Vac	5 min	--	--	The unit shut down and disconnected from the grid immediately. Components QA5, RA146, RA145, RA152, RA153, RA154, UA12, CA85, DA6, RA124, QD1, QD2, QD3 damaged. LCD no display. No hazards.
UA14 Pin1-2	S/C	Input: 850 Vdc Output: 230 Vac	5 min	--	--	DC fan speeded up. After about 3 min, the unit shut down and disconnected from the grid immediately. Components DA15, RA47, QA6, CA110, CA114, UA12, QA9 damaged. LCD no display. No hazards.
UA14 pin 3-4	S/C	Input: 850 Vdc Output: 230 Vac	5 min	--	--	The unit shut down and disconnected from the grid immediately. LCD no display. No damaged and no hazards.
AC Output	Re-verse Phase	Input: 850 Vdc Output: 230 Vac	5 min	--	--	Inverter did not work. No hazard.
TA1 Pin4-8	S/C	Input: 850 Vdc Output: 230 Vac	5min	--	--	The unit shut down and disconnected from the grid immediately. LCD no display. No damaged and no hazards.
TA1 Pin Pin 9-11	S/C	Input: 850 Vdc Output: 230 Vac	5 min	--	--	The unit shut down and disconnected from the grid immediately. LCD no display. No damaged and no hazards.
TA1 Pin14-16	S/C	Input: 850 Vdc Output: 230 Vac	5 min	--	--	The unit shut down and disconnected from the grid immediately. No damaged and no hazards.
12V_FANO UT to GND_fan	O/L	Input: 850 Vdc Output: 230 Vac	6 h 54 min	--	--	When 12V_fan overloaded to 1.2 A, FA2 opened and DC fan stop, the unit operating normal. No damaged and no hazards. The maximum temperature of TA1=70.6°C, Tamb=25.1°C
12V fan to GND_fan	S/C	Input: 850 Vdc Output: 230 Vac	5 min	--	--	The unit shut down and disconnected from the grid immediately. LCD no display. No damaged and no hazards.
+7VCOM to GND_fan	O/L	Input: 850 Vdc Output: 230 Vac	4 h 15 min	--	--	When +7V_com overloaded to 0.8 A, unit operating normal. When overloaded to 1A, after about 30 min, the unit shut down and disconnected from the grid. No damaged and no hazards. The maximum temperature of TA1=64.2°C, Tamb=24.2°C.

IEC 60255-27							
Clause	Requirement + Test				Result - Remark		Verdict
+7VCOM to GND_fan	S/C	Input: 850 Vdc Output: 230 Vac	5 min	--	--	The unit shut down and disconnected from the grid immediately. LCD no display. No damaged and no hazards.	
CB18 (for RCD)	S/C	Input: 850 Vdc Output: 230 Vac	5 min	--	--	The unit shut down and disconnected from the grid immediately. Error message: "ID20". No damaged and no hazards.	
Output	O/L	Input: 850 Vdc Output: 230 Vac	2 h 40 min	--	--	When output overloaded to 33.26 A, the unit output hiccup to 68 kW – 22.9 KW. When overloaded to 34 A, the unit shut down. Restart no damaged. No hazards. The maximum temperature of TA1=65.6°C, Tamb=26.3°C.	
Inside fan	Blocked	Input: 850 Vdc Output: 230 Vac	2 h 42 min	--	--	The unit operated normal. No damaged and no hazards. The maximum of temperature of TA1=65.6°C, Tamb=26.3 °C.	
Outside fan	Blocked	Input: 850 Vdc Output: 230 Vac	5 h 25 min	--	--	The unit operated normal. No damaged and no hazards. The maximum of temperature of TA1=68.7°C, Tamb=27.9 °C.	
Supplementary information: S/C: Short circuit, O/C: Open circuit During the test: Fire do not propagates beyond the EUT; Equipment do not emitt molten metal; Enclosures do not deform to cause non-compliance with the standard. Pass the dielectric test.							

7.3	TABLE: Heating Test						P
	Test voltage (V) .....					-	—
	Ambient (°C) .....					-	—
Thermocouple Locations	Max. temperature measured, (°C)						Max. temperature limit, (°C)
Test Condition	Test 1	Test 2	Test 3	Test 4	Test 5	Test 6	--
Ambient 1	45.0	45.0	45.0	45.0	45.0	45.0	--
Ambient 2	47.0	46.7	46.1	45.2	45.8	45.5	--
PV terminal	53.1	53.5	52.4	48.1	47.9	45.8	85
DC wire	66.3	65.5	62.2	57.5	53.4	51.4	90

IEC 60255-27							
Clause	Requirement + Test			Result - Remark			Verdict
Connector CNJ2	75.7	74.3	67.8	62.6	55.8	53.8	105
Connector CNF11	75.7	74.0	66.7	61.7	55.0	52.8	Ref.
PCB of fuse board	80.9	79.2	69.8	64.6	57.5	55.5	130
Wire (fuse board to DC switch)	74.4	73.5	66.4	61.0	54.2	52.2	90
DC switch	66.4	68.6	62.9	57.9	52.1	50.2	70
Y capacitor CA19	76.2	76.6	69.9	64.4	58.3	55.9	125
MOVA6	78.8	79.3	69.7	64.4	57.9	55.5	85
Capacitor CA24	77.2	76.7	70.5	65.1	58.5	56.4	105
Input inductor LA1	95.0	95.3	74.8	69.5	59.6	57.4	105
Capacitor CA25	74.7	73.3	71.0	65.1	57.3	55.5	105
Y capacitor CA29	78.9	77.1	71.9	66.3	59.8	57.5	125
Capacitor RYA1	77.2	75.6	72.5	67.5	59.6	57.6	85
Current transducer HLEA2	81.2	79.9	74.9	68.9	60.9	59.0	105
Connector CNA3	80.1	78.8	71.3	65.7	57.7	55.7	105
PCB of input board	86.9	86.8	73.1	67.8	59.2	57.0	130
Boost inductor lead wire	77.5	76.6	70.7	64.5	57.3	55.0	90
Boost inductor	96.7	102.7	66.8	60.4	53.4	51.4	105
DA18	70.6	70.0	76.2	69.9	56.3	54.0	Ref
DA19	86.8	85.5	67.6	61.2	53.2	50.8	Ref
Capacitor CA136	76.3	74.9	70.0	63.9	56.4	54.2	Ref
IGBT QA19	93.4	95.8	67.4	60.8	53.6	51.2	Ref
Capacitor CA145	75.2	73.3	70.4	64.2	56.0	54.1	85
Busbar Capacitor CD4	72.1	70.2	71.8	65.5	57.6	55.5	85
IGBT module	75.8	74.4	80.5	71.3	60.4	57.9	Ref
PCB of power board	79.9	77.5	85.3	76.7	62.6	59.9	130
Capacitor CD11	78.0	75.8	79.5	72.0	61.0	58.5	Ref
Transformer TA2	74.2	72.5	72.4	66.5	60.2	58.0	110
Y capacitor CYD2	71.6	70.6	67.7	61.9	55.0	52.9	125
Inverter inductor	81.7	79.1	97.1	86.0	76.5	73.0	105
Inverter inductor lead wire	72.8	70.7	72.5	66.0	57.6	55.4	90
Current transducer HLB2	73.4	71.3	72.1	66.1	57.5	55.6	105
X capacitor CB33	73.0	70.4	71.4	65.6	57.5	55.6	100
Capacitor CB36	72.4	69.7	70.3	64.4	57.4	55.2	85
Relay RLB3	70.7	68.3	67.2	61.8	55.0	52.8	85
Y capacitor CYB5	83.5	79.5	81.5	73.5	58.9	56.6	125
Output inductor LB1	76.7	75.4	77.5	71.2	59.7	57.3	105
X capacitor CB51	77.4	74.8	76.8	70.8	59.1	56.9	100



IEC 60255-27							
Clause	Requirement + Test			Result - Remark			Verdict
MOVB3	74.0	71.8	72.9	67.6	59.1	56.7	85
Output PCB	78.5	75.7	76.2	69.9	57.6	55.4	130
Output AC switch	68.6	66.9	66.1	60.4	53.5	51.6	70
AC output wire	74.9	72.7	72.8	66.4	57.4	55.7	80
Output terminal	67.4	65.9	64.6	59.2	53.1	51.1	Ref.
DC fan (inside)	67.8	68.5	67.3	63.8	57.6	55.5	70
Control board Input wire	74.5	72.6	73.6	67.7	66.7	63.0	90
Connector CNBA3	79.2	77.4	79.2	73.3	71.8	69.1	105
Capacitor CA75	78.9	77.5	80.7	75.2	70.7	70.8	85
QA5	81.8	80.2	85.1	79.4	80.9	77.8	Ref
Transformer TA1	82.5	81.1	83.2	78.6	75.5	73.1	110
Opto-coupler UC68	81.3	79.5	80.0	74.9	67.1	64.9	100
PCB of Control board	78.7	77.1	77.5	73.1	66.5	64.4	130
Opto-coupler UF14	68.7	67.6	66.3	60.4	54.3	52.0	100
DC fan (outside)	51.2	52.4	55.0	50.3	50.5	48.8	70
Accessible enclosure surface (Front)	62.7	60.7	61.0	56.7	53.1	50.9	100
Display button	58.1	56.8	56.7	53.0	51.1	49.0	85
Accessible enclosure surface (Side)	63.8	62.6	64.3	59.0	53.5	51.4	70
Accessible enclosure surface (Top)	63.4	62.1	65.1	59.3	54.1	51.7	70
Mounting surface	70.4	68.9	75.9	67.7	56.7	53.9	90
Switch knob	49.1	46.3	48.9	44.9	46.4	44.3	85
Supplementary information:							
	Ambient temperature (°C)		Input voltage (Vdc)		Output voltage (Vac)		Output power (W)
Test 1	45		430		230		20000
Test 2	45		430		253		20000
Test 3	45		850		230		20000
Test 4	45		850		253		20000
Test 5	45		960		230		8010
Test 6	45		960		253		8020
<b>Temperature rise of winding</b>	<b>R<sub>1</sub> (Ω)</b>	<b>R<sub>2</sub> (Ω)</b>	<b>ΔT (K)</b>	<b>Max. dT (K)</b>			<b>Insulation class</b>
--	--	--	--	--			--
Supplementary information:							

IEC 60255-27			
Clause	Requirement + Test	Result - Remark	Verdict

7.3	TABLE: Heating Test						P
	Test voltage (V) .....					-	—
	Ambient (°C) :					-	—
Thermocouple Locations	Max. temperature measured, (°C)						Max. temperature limit, (°C)
Test Condition	Test 7	Test 8	Test 9	Test 10	Test 11	Test 12	--
Ambient 1	60.9	60.4	61.1	60.6	62.1	62.3	--
Ambient 2	61.5	61.4	62.1	61.4	62.5	62.5	--
PV terminal	64.6	64.9	64.1	64.1	62.9	63.1	85
DC wire	69.7	70.2	69.0	69.0	67.9	68.1	90
Connector CNJ2	72.6	73.2	71.2	71.1	70.2	70.3	105
Connector CNF11	72.1	72.5	70.6	70.5	69.2	69.3	Ref.
PCB of fuse board	73.4	74.0	72.7	72.5	71.7	71.9	130
Wire (fuse board to DC switch)	72.0	72.6	69.8	69.7	68.6	68.7	90
DC switch	68.3	68.9	68.0	68.0	66.8	66.9	70
Y capacitor CA19	74.6	75.3	73.7	73.6	72.2	72.3	125
MOVA6	75.0	76.1	73.3	73.1	71.9	71.8	85
Capacitor CA24	75.4	76.2	73.9	73.7	72.8	72.5	105
Input inductor LA1	79.4	81.0	75.1	74.9	73.6	73.4	105
Capacitor CA25	74.0	74.7	72.7	72.5	71.8	72.1	105
Y capacitor CA29	76.0	76.7	75.2	74.9	74.0	73.5	125
Capacitor RYA1	75.7	76.3	74.8	74.6	73.9	73.7	85
Current transducer HLEA2	76.8	77.4	76.0	75.8	75.4	75.7	105
Connector CNA3	74.2	74.9	73.0	72.7	72.1	72.1	105
PCB of input board	77.5	78.7	74.7	74.4	73.3	73.1	130
Boost inductor lead wire	74.4	75.4	72.5	72.1	71.5	71.3	90
Boost inductor	85.0	90.7	69.2	68.8	67.8	67.7	105
DA18	71.4	71.8	72.5	72.2	69.4	69.4	Ref
DA19	76.3	76.6	69.0	68.6	67.0	66.9	Ref
Capacitor CA136	74.0	74.5	71.8	71.5	70.6	70.5	Ref
IGBT QA19	79.6	81.1	69.3	68.9	67.6	67.5	Ref
Capacitor CA145	73.4	73.7	71.7	71.4	70.4	70.3	85
Busbar Capacitor CD4	72.8	73.1	73.0	72.7	71.8	71.6	85
IGBT module	73.3	73.5	75.6	74.9	73.9	73.5	Ref
PCB of power board	75.5	75.8	77.5	76.6	75.4	75.0	130
Capacitor CD11	75.3	75.6	76.2	75.5	74.4	74.1	Ref

IEC 60255-27							
Clause	Requirement + Test				Result - Remark		Verdict
Transformer TA2	75.3	75.7	75.6	75.2	74.4	74.3	110
Y capacitor CYD2	72.5	73.0	70.6	70.3	69.3	69.3	125
Inverter inductor	75.4	76.0	86.8	85.0	90.0	88.7	105
Inverter inductor lead wire	72.4	72.7	72.8	72.4	71.7	71.5	90
Current transducer HLB2	73.3	73.7	73.0	72.9	71.9	71.9	105
X capacitor CB33	72.9	73.4	72.9	72.8	71.9	72.0	100
Capacitor CB36	72.1	72.4	72.5	72.2	71.7	71.6	85
Relay RLB3	71.2	71.6	70.6	70.4	69.3	69.4	85
Y capacitor CYB5	75.2	75.2	74.5	74.0	72.7	72.7	125
Output inductor LB1	75.5	75.7	75.3	74.7	72.7	72.6	105
X capacitor CB51	75.1	75.3	74.5	74.2	73.0	73.2	100
MOVB3	74.7	75.0	74.6	74.4	73.0	73.5	85
Output PCB	73.9	74.1	73.1	72.9	71.5	71.8	130
Output AC switch	68.6	68.0	69.3	69.2	68.0	68.1	70
AC output wire	73.6	73.9	72.9	72.7	71.9	71.9	80
Output terminal	70.0	70.4	68.8	68.8	67.6	67.7	Ref.
DC fan (inside)	68.7	69.1	69.2	69.1	69.0	68.9	70
Control board Input wire	76.1	76.7	80.9	80.9	80.0	76.7	90
Connector CNBA3	80.0	80.9	85.2	85.3	86.7	81.2	105
Capacitor CA75	82.2	82.8	83.6	83.8	84.5	82.6	85
QA5	85.2	85.2	90.6	91.2	94.2	93.9	Ref
Transformer TA1	86.0	86.7	90.1	90.0	89.5	89.3	110
Opto-coupler UC68	83.9	84.1	82.8	82.5	81.3	81.5	100
PCB of Control board	81.0	81.2	82.0	81.8	80.8	81.1	130
Opto-coupler UF14	71.1	71.6	69.8	69.7	69.4	68.4	100
DC fan (outside)	67.8	68.1	66.9	67.1	65.2	65.7	70
Accessible enclosure surface (Front)	68.7	68.8	68.8	68.9	67.6	67.8	100
Display button	66.9	67.0	67.0	67.2	65.8	66.1	85
Accessible enclosure surface (Side)	69.2	69.5	69.1	69.0	67.8	67.9	70
Accessible enclosure surface (Top)	68.7	69.0	69.6	69.7	68.4	68.2	70
Mounting surface	71.0	71.4	72.3	71.2	69.7	69.4	90
Switch knob	62.4	63.2	61.9	62.2	61.5	61.7	85
Supplementary information:							
	Ambient temperature (°C)		Input voltage (Vdc)		Output voltage (Vac)		Output power (W)
Test 7	60		430		230		8272

IEC 60255-27					
Clause	Requirement + Test			Result - Remark	Verdict
Test 8	60		430	253	8110
Test 9	60		850	230	8100
Test 10	60		850	253	8197
Test 11	60		960	230	6010
Test 12	60		960	253	6050
Temperature rise of winding	R <sub>1</sub> (Ω)	R <sub>2</sub> (Ω)	ΔT (K)	Max. dT (K)	Insulation class
--	--	--	--	--	--
Supplementary information:					

7.6	TABLE: Flammability of materials and components					N/A
Object/ Part No./ Material	Manufacturer/ trademark	Duration of application of test flame (ta); (s)	Ignition of specified layer Yes/No	Duration of burning (tb) (s)	Verdict	
--	--	--	--	--	--	
Supplementary information:						
Part	Manufacturer of material	Type of material	Thickness (mm)	Flammability class	Evidence	
--	--	--	--	--	--	
Supplementary information:						

8.3	TABLE: Critical components information					P
Object / part No.	Manufacturer/ trademark	Type / model	Technical data	Standard	Mark(s) of conformity <sup>1)</sup>	
DC input PV connector (for model "-S2" to "- S6")	Amphenol Industrial Operations	Helios H4	4 mm <sup>2</sup> , DC 1000 V, 40 A, 120°C	EN 50521	TUV Rheinland	
(Alternative)	Phoenix Contact GmbH & Co. KG	PV-FT-CF-C-4 PV-FT-CM-C-4	DC 1000 V, 4 mm <sup>2</sup> , 40 A, 85°C	EN 50521	TUV Rheinland	

IEC 60255-27					
Clause	Requirement + Test			Result - Remark	Verdict
DC inside connector (for model "-S0" to "-S2")	Jite Industrial (Shenzhen) Co Ltd	RTB450-00	1000 V	IEC 60255-27	Tested with appliance
(Alternative)	Phoenix Contact GmbH & Co. KG	UK 35	1000 V, 150 A, 125°C	EN 60947-7-1	KEMA-KEUR
Internal wiring (for PV terminal to fuse board) (for model "-S3" to "-S6")	Various	1032 or 10269	12AWG, 1000V, 90°C or better	UL 758	UL
Internal wiring (for power board to control board)	Various	1032 or 10269	22AWG, 1000V, 90°C or better	UL 758	UL
Internal wiring (for the other DC input)	Various	1032 or 10269	10AWG, 1000V, 90°C or better	UL 758	UL
Internal wiring (for AC output)	Various	1015	10AWG, 300 V or better, 80°C or better	UL 758	UL
DC switch (for model "-S1" to "-S6")	Santon International B.V.	XA100.16	1000 Vdc/ 16 A, 800 Vdc/ 25 A, 4 poles, 70°C, 4 poles	EN 60947-3	KEMA-KEUR
(Alternative)	Sensata Technologies Changzhou Co., Ltd.	PVSW10FDF1 - 25F4-2-000	1000 Vdc, 25 A, 70°C, 4 poles	EN 60947-3	TUV Rheinland
(Alternative)	Merz Schaltgerate GmbH + Co KG	MDC1A-025-600	1000 Vdc, 25 A, IP65, 4 poles	EN 60947-1 EN 60947-3	KEMA-KEUR
Connector on fuse PCB and input PCB (CNJ1, CNJ2, CNK1, CNK2, CNA1, CNA3, CNA8)	Phoenix Contact GmbH & Co Kg	MKDSP 10N/ 2-10.16	AC 1000 V, 105°C	IEC 60255-27	Tested with appliance
(Alternative)	Dinkle Enterprise Co. Ltd.	ESK116	1000 V, 57 A	IEC 60255-27	Tested with appliance
Connector on control PCB (CNBA3)	Phoenix Contact GmbH & Co Kg	MKDS 5 HV/ 2-9.52	AC 1000 V, 105°C	IEC 60255-27	Tested with appliance
(Alternative)	Dinkle Enterprise Co. Ltd.	EK950	AC 1000 V, 105°C	IEC 60255-27	Tested with appliance
Fuse on fuse PCB (for model "-S3" to "-S6")	Bussmann	PV-15A-10F	1000 Vdc, 15 A, 10x38 mm	IEC 60255-27	Tested with appliance
(Alternative)	Littelfuse, Inc.	SPF	1000 Vdc, 15 A, 10x38 mm	IEC 60269-6	VDE

IEC 60255-27					
Clause	Requirement + Test			Result - Remark	Verdict
(Alternative)	Various	Various	1000 Vdc, 15 A, 10x38 mm	IEC 60269-6	VDE
DC surge ar- rester (for model "-S4" to "-S6")	Shanghai Citel electronics Co., Ltd	DS50PVS- 1000	1000 Vdc, 85°C	IEC 60255-27	Tested with appliance
(Alternative)	Shanghai Citel Electronics Co., Ltd	DS50PV-1000	1000 Vdc, 85°C	IEC 61643-1 IEC 60255-27	TUV PS Tested with appliance
(Alternative)	Zhongguang Hi- tech	ZGG40- 1000(2+1)PV	1200 Vdc, 85°C	IEC 60255-27	Tested with appliance
PCB	Total Electronics Ltd	1368MLB	130°C, V-0, Min thickness: 1.6 mm	UL94 IEC 60255-27	UL Tested with appliance
(Alternative)	Shantou Lucky Star Pcb Co Ltd	WS888	130°C, V-0, CTI: min.175, Min thickness: 1.6 mm	UL94	UL
(Alternative)	Various	Various	130°C, V-0, CTI: min.175, Min thickness: 1.6 mm	UL94	UL
-PCB material	Shengyi Technology Co Ltd	S1000 S1141	130°C, V-0, CTI: min.175	UL94	UL
(Alternative)	Various	Various	130°C, V-0, CTI: min.175	UL94	UL
Capacitor (CA12, CA25)	Chang Jie	LBB61	30 µF, 1100 Vdc, 85°C	IEC 60255-27	Tested with appliance
(Alternative)	Faratronic	C3D	30 µF, 1100 Vdc, 85°C	IEC 60255-27	Tested with appliance
X capacitor on output PCB (CB24, CB33, CB42, CB49, CB51, CB52, CB54, CB56, CB57)	Shantou High- New Technology Dev. Zone Song- tian Enterprise Co., Ltd	MPX	X2, 2.2 µF, 305 Vac, 110°C	IEC 60384-14	VDE
(Alternative)	Various	Various	X2, 2.2 µF, 305 Vac, 100°C or above	IEC 60384-14	VDE or other EU certificate
Y capacitor on input PCB, con- trol PCB and power PCB (CA10, CA11, CA13, CA14, CA17, CA18, CA19, CA21, CA26, CA29, CA31, CA32, CYD1, CYD2, CYD3, CYD4)	Shantou High- New Technology Dev. Zone Song- tian Enterprise Co., Ltd	CD	4700 pF, 400 Vac, Y1, 125°C	IEC 60384-14	VDE
(Alternative)	VISHAY Elec- tronic GmbH	VY1	4700 pF, 500 Vac, Y1, 125°C	IEC 60384-14	VDE

IEC 60255-27					
Clause	Requirement + Test			Result - Remark	Verdict
(Alternative)	Various	Various	4700 pF, 400 Vac or above, Y1, 125°C	IEC 60384-14	VDE or other EU certificate
Y capacitor on output PCB (CYB1, CYB2, CYB4, CYB5, CYB7, CYB8, CYB11)	Shantou High-New Technology Dev. Zone Song-tian Enterprise Co., Ltd	CE	Y2, 250 Vac, 100 pF, 125°C	IEC 60384-14	VDE
(Alternative)	Various	Various	Y1 or Y2, 250 Vac, 100 pF, 125°C	IEC 60384-14	VDE or other EU certificate
Y capacitor on output PCB (CYB3, CYB6, CYB9)	Shantou High-New Technology Dev. Zone Song-tian Enterprise Co., Ltd	CE	Y2, 250 Vac, 10000 pF, 125°C	IEC 60384-14	VDE
(Alternative)	Various	Various	Y1 or Y2, 250 Vac, 10000 pF, 125°C	IEC 60384-14	VDE or other EU certificate
Varistor on input PCB and output PCB (MOVA1, MOVA2, MOVA3, MOVA4, MOVA5, MOVA6, MOVB1, MOVB2, MOVB3, MOVB4)	Dongguan Littelfuse Electronics Co Ltd	V1000LA160B P	1000 Vac, 1200Vdc, 85 °C	IEC 61051-1 IEC 61051-2 IEC 61051-2-2	VDE
Input inductor (LA1)	Bo Luo Da Xin Electronic Co.,Ltd	SH-L001	130°C, Class B	IEC 60255-27	Tested with appliance
(Alternative)	Huizhou Baohui Electronics Technology Co.,Ltd	SH-L001	130°C, Class B	IEC 60255-27	Tested with appliance
- Winding of the input inductor	Various	Various	130°C or above, Φ2.0 mm	UL 1446	UL
Current transducer (HLEA1, HLEA2)	LEM	HXN25-P	25 A	IEC 60255-27	Tested with appliance
(Alternative)	TAMURA CORP	L18P025D15	25 A	IEC 60255-27	Tested with appliance
Boost chock (for Sofar 20000TL- Sx)	Bo Luo Da Xin Electronic Co., Ltd	SH-L003	1800 μH, 130°C	IEC 60255-27	Tested with appliance
(Alternative)	Huizhou Baohui Electronics Technology Co., Ltd	SH-L003	1800 μH, 130°C	IEC 60255-27	Tested with appliance

IEC 60255-27					
Clause	Requirement + Test			Result - Remark	Verdict
Boost chock (for Sofar 17000TL- Sx, Sofar 15000TL-Sx)	Bo Luo Da Xin Electronic Co.,Ltd	SH-L009	2100 $\mu$ H, 130°C	IEC 60255-27	Tested with appliance
(Alternative)	Huizhou Baohui Electronics Technology Co., Ltd	SH-L009	2100 $\mu$ H, 130°C	IEC 60255-27	Tested with appliance
Boost chock (for Sofar 10000TL- Sx)	Bo Luo Da Xin Electronic Co., Ltd	SH-L013	3000 $\mu$ H, 130°C	IEC 60255-27	Tested with appliance
(Alternative)	Huizhou Baohui Electronics Technology Co., Ltd	SH-L013	3000 $\mu$ H, 130°C	IEC 60255-27	Tested with appliance
- Lead wire of the boost chock	Various	1032 or 10269	10AWG, 1000 V, 90°C or better	UL 758	UL*
- Winding of the boost chock	Various	Various	130°C or above, $\Phi$ 2.1 mm	UL 1446	UL*
- Insulation tape of the boost chock	Jingjiang Yahua Pressure Sensi- tive Glue Co Ltd	CT, WF	Min 130°C	UL 510	UL*
(Alternative)	Various	Various	130°C	UL 510	UL*
- Pouring mater- ial of the boost chock	Jiangsu Feixiang Chemical Co Ltd	DG8626A&B	V-0, 105°C	UL 94	UL*
(Alternative)	Various	Various	V-0, min.105°C	UL 94	UL*
Inverter chock (for Sofar 20000TL-Sx)	Bo Luo Da Xin Electronic Co., Ltd	SH-L002	730 $\mu$ H, 130°C	IEC 60255-27	Tested with appliance
(Alternative)	Huizhou Baohui Electronics Technology Co., Ltd	SH-L002	730 $\mu$ H, 130°C	IEC 60255-27	Tested with appliance
Inverter chock (for Sofar 17000TL-Sx)	Bo Luo Da Xin Electronic Co., Ltd	SH-L011	850 $\mu$ H, 130°C	IEC 60255-27	Tested with appliance
(Alternative)	Huizhou Baohui Electronics Technology Co., Ltd	SH-L011	850 $\mu$ H, 130°C	IEC 60255-27	Tested with appliance
Inverter chock (for Sofar 15000TL-Sx)	Bo Luo Da Xin Electronic Co., Ltd	SH-L010	960 $\mu$ H, 130°C	IEC 60255-27	Tested with appliance
(Alternative)	Huizhou Baohui Electronics Technology Co., Ltd	SH-L010	960 $\mu$ H, 130°C	IEC 60255-27	Tested with appliance



IEC 60255-27					
Clause	Requirement + Test			Result - Remark	Verdict
Inverter chock (for Sofar 10000TL-Sx)	Bo Luo Da Xin Electronic Co., Ltd	SH-L012	1460 $\mu$ H, 130°C	IEC 60255-27	Tested with appliance
(Alternative)	Huizhou Baohui Electronics Technology Co., Ltd	SH-L012	1460 $\mu$ H, 130°C	IEC 60255-27	Tested with appliance
- Lead wire of the inverter chock	Various	1015, 1032 or 10269	10AWG, Min 300 V, 90°C or better	UL 758	UL
- Winding of the inverter chock	Various	Various	130°C or above, $\Phi$ 1.8 mm	UL 1446	UL
- Insulation tape of the inverter chock	Jingjiang Yahua Pressure Sensitive Glue Co Ltd	CT, WF	130°C	UL 510	UL
(Alternative)	Various	Various	130°C	UL 510	UL
- Pouring material of the inverter chock	Jiangsu Feixiang Chemical Co Ltd	DG8626A&B	V-0, 105°C	UL 94	UL
(Alternative)	Various	Various	V-0, 105°C or above	UL 94	UL
IGBT module (QD1, QD2, QD3)	Vincotech (Hungary) Ltd	10-FZ12NMA080 S H01-M260F	1200 V, 80 A	IEC 60255-27	Tested with appliance
(Alternative)	Infineon	DS_F3L80R1 2W 1H3_B11	1200 V, 80 A	IEC 60255-27	Tested with appliance
(Alternative)	Vincotech (Hungary) Ltd	10-FZ12NMA040 SH-M267F (only for model Sofar 15000TL-Sx and 10000TL-Sx)	1200 V, 40 A	IEC 60255-27	Tested with appliance
Insulating sheet between IGBT and heat sink	Bergquist Co	K-10	Min 0.13 mm, VTM-0, 150°C	IEC 60255-27	Tested with appliance
(Alternative)	Bergquist Co	900S	Min 0.2 mm, V- 0, 150°C	IEC 60255-27	Tested with appliance
(Alternative)	Laird Technologies	K52	V-0, 0.051 mm	IEC 60255-27	Tested with appliance
Insulating sheet (between power board and enclosure)	Mianyang Longhua Film Co Ltd	PP-BK18	V-0, min 0.4 mm, 100°C	IEC 60255-27	Tested with appliance
(Alternative)	Formex, Div Of Illinois Tool Works Inc, Formerly	FORMEX GK-(a)(b)(f2)	VTM-0, 115°C, Min 0.2 mm	IEC 60255-27	Tested with appliance

IEC 60255-27					
Clause	Requirement + Test			Result - Remark	Verdict
(Alternative)	Sabic Innovative Plastics Us LLC	FR1, FR7, FR25	V-0, 125°C, min 0.23 mm thickness	IEC 60255-27	Tested with appliance
Busbar Capacitor (CA129, CA131, CA145, CA148) (for 20 kW & 17 kW models incorporating all 4 capacitors; for 15 kW models incorporating any 3 capacitors; for 10 kW models incorporating any 2 capacitors)	Faratronic	C3D	30 $\mu$ F, 1100 Vdc, 85°C	IEC 60255-27	Tested with appliance
(Alternative)	Chang Jie	LBB61	30 $\mu$ F, 1100 Vdc, 85°C	IEC 60255-27	Tested with appliance
Busbar Capacitor (CD1, CD2, CD3, CD4, CD5, CD6, CD7, CD8, CD39, CD40) (for 20 kW models incorporating all 10 capacitors; 17 kW models incorporating any 8 capacitors; for 15 kW models incorporating any 6 capacitors; for 10 kW models incorporating any 4 capacitors)	Faratronic	C3D	700 Vdc, 75 $\mu$ F, 85°C	IEC 60255-27	Tested with appliance
(Alternative)	Chang Jie	LBB61	700 Vdc, 75 $\mu$ F, 85°C	IEC 60255-27	Tested with appliance

IEC 60255-27					
Clause	Requirement + Test			Result - Remark	Verdict
Transformer on power PCB (TA2, TE1*6pcs)	Bo Luo Da Xin Electronic Co., Ltd	SH-T001	Class B	IEC 60255-27	Tested with appliance
(Alternative)	Huizhou Baohui Electronics Technology Co., Ltd	SH-T001	Class B	IEC 60255-27	Tested with appliance
- Winding	E&B Technology Co Ltd	E&B-XXXB	130°C(Class B)	UL2353	UL
(Alternative)	Furukawa Electric Co Ltd	TEX-E	130°C(Class B)	UL2353	UL
(Alternative)	Huizhou Huiqiang Electronics Co Ltd	JY0160	155°C (Class F)	UL2353	UL
- Bobbin	Sumitomo Bakelite Co Ltd	PM 9630 or PM9820	V-0, 150°C	IEC 60255-27	Tested with appliance
(Alternative)	Chang Chun Plastics Co Ltd	T375HF	V-0, 150°C	IEC 60255-27	Tested with appliance
- Insulating tape	Jingjiang Yahua Pressure Sensitive Glue Co Ltd	CT	130°C	UL 510	UL
Output inductor (LB1, LB2)	Bo Luo Da Xin Electronic Co., Ltd	SH-L004	2.4 µH, 130°C	IEC 60255-27	Tested with appliance
(Alternative)	Huizhou Baohui Electronics Technology Co., Ltd	SH-L004	2.4 µH, 130°C	IEC 60255-27	Tested with appliance
Output inductor (LB3, LB4, LB5)	Bo Luo Da Xin Electronic Co., Ltd	SH-L005	13.5 µH, 130°C	IEC 60255-27	Tested with appliance
(Alternative)	Huizhou Baohui Electronics Technology Co., Ltd	SH-L005	13.5 µH, 130°C	IEC 60255-27	Tested with appliance
- Winding of the output inductor	Various	Various	130°C or above, Φ1.2 mm	UL 1446	UL
Relay (RLB1, RLB2, RLB3, RLB4, RLB5, RLB6)	Panasonic Corporation Ise Factory	ALFG2PF12 ALFG2PF121	250 V, 31 A, 12 Vdc, 85°C, 30000 cycles	IEC/EN 61810-1	VDE

IEC 60255-27					
Clause	Requirement + Test			Result - Remark	Verdict
(Alternative)	Fujitsu Component Limited	FTR-K3AB012W-PV FTR-K3AB012W-PS	250 V, 32 A, 12 Vdc, 85°C, 30000 cycles	IEC/EN 61810-1	VDE
Current transducer (HLB1, HLB2, HLB3)	LEM	CASR25-NP	25 A	IEC 60255-27	Tested with appliance
(Alternative)	VAC	T60404-N4646- X661	25 A	IEC 60255-27	Tested with appliance
(Alternative)	TAMURA	F02P025S05	25 A	IEC 60255-27	Tested with appliance
AC surge arrester (for model "-S5" to "-S6")	Shanghai Citel electronics Co., Ltd	DS44S-400/G	400 Vac, 85°C	IEC 60255-27	Tested with appliance
(Alternative)	Zhongguang Hi-tech	ZGG40-385(3+1)	230 Vac, 80°C	IEC 60255-27	Tested with appliance
AC switch (for model "-S6")	Merz GmbH	ML1-040	690 Vac, 40 A	EN 60947-3	KEMA
AC output connector	Shenzhen Succeed Electronics Technology Co Ltd	TR-35N	600 V, 115 A, 115°C	IEC 60255-27	Tested with appliance
(Alternative)	Phoenix Contact GmbH & Co. Kg	UK 5 N	800 V, 32 A	IEC 60255-27	Tested with appliance
Transformer on control PCB (TA1)	Huizhou Baohui Electronics Technology Co., Ltd	SH-T002	Class B	IEC 60255-27	Tested with appliance
(Alternative)	Bo Luo Da Xin Electronic Co., Ltd	SH-T002	Class B	IEC 60255-27	Tested with appliance
- Bobbin of the transformer	Sumitomo Bakelite Co Ltd	PM-9820 PM-9830	150°C, V-0	IEC 60255-27	Tested with appliance
(Alternative)	Chang Chun Plastics Co Ltd	T375HF	V-0, 150°C	IEC 60255-27	Tested with appliance
- Insulating tape of the transformer	Jingjiang Yahua Pressure Sensitive Glue Co Ltd	CT	130°C	UL 510	UL

IEC 60255-27					
Clause	Requirement + Test			Result - Remark	Verdict
(Alternative)	Various	Various	130°C	UL 510	UL
- Margin Tape	Jingjiang Yahua Pressure Sensitive Glue Co Ltd	WF	130°C	UL 510	UL
(Alternative)	Various	Various	130°C	UL 510	UL
- Magnet wire of the transformer	Tai-I Electric Wire & Cable Co Ltd	UEW	130°C, $\Phi 0.45$ mm	UL 1446	UL
(Alternative)	Various	Various	130°C, $\Phi 0.45$ mm	UL 1446	UL
- Tubing of the transformer	Shenzhen Woer Heat-Shrinkable Material Co Ltd	WF	600 V, 200°C	UL 224	UL
(Alternative)	Various	Various	600 V, 200°C	UL 224	UL
- Varnishes	Suzhou Taihu Electric Advanced Material Co Ltd	T-4260	130°C	UL 1446	UL
(Alternative)	Various	Various	130°C	UL 1446	UL
Optocoupler	Lite-On Technology Corporation	LTV816	Cr. $\geq 7.0$ mm, Cl. $\geq 7.0$ mm, 55/115/21	EN 60747-5-5	VDE*
Inductor on control PCB (LA2, LA4, LA10, LA12, LA14)	Huizhou Baohui Electronics Technology Co., Ltd	SH-L006	130°C	IEC 60255-27	Tested with appliance
(Alternative)	Bo Luo Da Xin Electronic Co., Ltd	SH-L006	130°C	IEC 60255-27	Tested with appliance
- Winding of the inductor on control PCB	Various	Various	130°C or above, $\Phi 0.35$ mm	UL 1446	UL
Outer fan	Sanyo Denki Co Ltd	9WP0812H401	12 Vdc/ 0.13 A, IP55, 70°C, CFM=53	EN 60950-1 IEC 60255-27	TUV Rheinland Tested with appliance
(Alternative)	Adda Corporation	AQ0812HB-A73GL	12 Vdc/ 0.24 A, IP58, 70°C, CFM=34.78	EN 60950-1 IEC 60255-27	TUV Rheinland Tested with appliance
Inner fan	Adda Corporation	AD0612MB-A73GL	12 Vdc, 0.14 A	EN 60950-1 IEC 60255-27	TUV Rheinland Tested with appliance
(Alternative)	Kaimei Electronic Corp.	JF0625B1MS	12 Vdc, 0.2 A	EN 60950-1 IEC 60255-27	TUV Rheinland Tested with appliance

IEC 60255-27					
Clause	Requirement + Test			Result - Remark	Verdict
LCD panel	Teijin Chemicals Plastic Com-pounds Shanghai Ltd	L-1250Z(#)(f1)	V-2, 80°C, Anti- UV	IEC 60255-27	Tested with appliance
Supplementary information: <sup>1)</sup> an asterisk indicates a mark which assures the agreed level of surveillance.					

10.6.3	TABLE: Clearance And Creepage Distance Measurements						P
clearance cl and creepage distance dcr at/of:	Up (V)	U r.m.s. (V)	Required cl (mm)	cl (mm)	required dcr (mm)	dcr (mm)	
Between “+” and “-“ of DC input (FI)	1000 Vp	1000 VDC	3.6	6.2	5.0	6.2	
Two poles of DC fuse (FI)	1000 Vp	1000 VDC	3.6	6.0	5.0	6.0	
Between L and N of AC output (FI)	325 Vp	230 VAC	3.0	4.3	3.0	4.3	
Between Lines of AC output (FI)	566 Vp	400 VAC	3.0	3.8	3.0	3.8	
DC live part and earthed metal (BI)	1000 Vp	1000 VDC 230 VAC	3.6	6.4	5.0	6.4	
AC live part and earthed metal (BI)	1000 Vp	1000 VDC 230 VAC	3.6	5.5	5.0	5.5	
Input lead wire to plastic accessible surface (SI)	1000 Vp	1000 VDC 230 VAC	3.6	16.0	10.0	16.0	
DC live part to the accessible surface of the input terminal (RI)	1000 Vp	1000 VDC 230 VAC	6.1	23.0	20.0	23.0	
AC live part to the accessible surface of the output terminal (RI)	1000 Vp	1000 VDC 230 VAC	6.1	36.0	20.0	36.0	
Primary circuit and secondary circuit of the auxiliary power (on PCB) (RI)	1090 Vp	225 VAC	5.5	10.0	8.0	10.0	
Supplementary information: RI: Reinforced insulation, DI: double insulation, BI: basic insulation, SI: supplementary insulation The double side PCB layout is considered and evaluated.							

10.6.4.2/ 10.6.4.3	TABLE: Impulse voltage test/Dielectric Strength			P
Test voltage applied between:	impulse withstand voltage (kV) 1.2/50 μs	Test voltage (Vdc)	Breakdown / flashover (Yes/No)	
PV input and Ground (BI)	6.0	2120	No	
AC mains output and Ground (BI)	6.0	2120	No	

IEC 60255-27			
Clause	Requirement + Test	Result - Remark	Verdict
PV input and communication output port (RI)	8.0	4240	No
AC mains and communication output port (RI)	8.0	4240	No
PV input terminal to LCD screen cover(RI)	8.0	4240	No
AC output terminal to LCD screen cover(RI)	8.0	4240	No
Supplementary information: RI: Reinforced insulation, DI: double insulation, BI: basic insulation, SI: supplementary insulation The double side PCB layout is considered and evaluated.			

10.6.4.4	TABLE: insulation resistance measurements	P
Insulation resistance R between:	R (MΩ)	Required R (MΩ)
Between mains poles (primary fuse disconnected)	>100	10
Between parts separated by basic or supplementary insulation	>100	10
Between parts separated by double or reinforced insulation	>100	10
Supplementary information:		

IEC 60255-27			
Clause	Requirement + Test	Result - Remark	Verdict

### Attachment 1: Vibration, Shock, Bump, Seismic test report



LCJC-JL-708-02 A/0

Report No.: LCJC201903074YW001

Date Issued: Apr. 02, 2019

## 苏州茌测检测技术服务有限公司

Suzhou Longce Testing Technology Service Co., Ltd.

### 检测报告

Test Report

Test Items: Vibration ,Shock, Bump, Seismic test  
 Sample Name: PV Inverter  
 Consigner: DEKRA Testing and Certification (Shanghai) Ltd.  
 Test Type: Entrust Test

Prepared By:

Yao Jun

Checked By:

Wang fei

Approved by:

Jitian



Authorized signatory

Suzhou Longce Testing Technology Service Co., Ltd.  
<http://www.szlcjc.com>



IEC 60255-27			
Clause	Requirement + Test	Result - Remark	Verdict



LCJC-JL-708-02 A/0

### 1. GENERAL INFORMATION

Equipment Under Test (EUT)	PV Inverter
Model	SOFAR 2000TL-Sx Series, SOFAR 1700TL-Sx Series SOFAR 1500TL-Sx Series, SOFAR 1000TL-Sx Series
Quantity of Tested Samples	1 PCS
Samples Code	LCJC2019032500301
Entrust unit name	DEKRA Testing and Certification (Shanghai) Ltd.
Entrust unit address	3F, #250 Jiangchangsan Road, Building 16, Headquarter Economy Park Shibei Hi-Tech Park, Zhabei District, Shanghai 200436, China
Manufacture unit name	Shenzhen SOFAR SOLAR Co., Ltd.
Manufacture unit address	401, Building 4, AnTongDa Industrial Park, District 68, XingDong Community, XinAn Street, BaoAn District, Shenzhen, China.
Sample delivery personnel information	Stone.Wang@dekra.com
Sample status	Conform to the requirements of the test
Received the sample date	Mar. 22, 2019
Test date	Mar. 26, 2019~Mar. 29, 2019
Test standard	IEC 60255-27:2013 Measuring relays and protection equipment - Part 27: Product safety requirements; IEC60255-21-1:1988 Vibration, shock, bump and seismic tests on measuring relays and protection equipment. Section 1 : Vibration tests (sinusoidal) ; IEC60255-21-2:1988 Vibration, shock, bump and seismic tests on measuring relays and protection equipment. Section 2: Shock and bump tests; IEC60255-21-3:1993 Vibration, shock, bump and seismic tests on measuring relays and protection equipment. Section 3: Seismic tests.
Test engineer	Yao Jun
Temperature	25±5℃
Humidity	<70%RH

IEC 60255-27			
Clause	Requirement + Test	Result - Remark	Verdict



LCJC-JL-708-02 A/0

## 2. TEST ITEMS AND RESULT

No.	Test Item	Test Information	Test Result	Verdict
1	Vibration response test	1.Frequency: 10~150Hz; 2.Cross-over Frequency: 58~60Hz; 3.Peak Displacement: 0.035mm; 4.Acceleration: 0.5g; 5.Cycle Time: 8min /axis; 6.Direction: X, Y, Z axis.	The appearance of the sample was normal.	Pass
	Vibration endurance test	1.Frequency: 10~150Hz; 2.Acceleration: 1g; 3.Cycle Time: 8min /axis, total 20 cycles/axis; 4.Direction: X, Y, Z axis.	The appearance of the sample was normal.	Pass
2	Shock response test	1.Acceleration: 5g; 2.Duration: 11ms; 3.Times: 3times/direction, total 18times. 4.Direction: ±X, ±Y, ±Z axis.	The appearance of the sample was normal.	Pass
	Shock withstand test	1.Acceleration: 15g; 2.Duration: 11ms; 3.Times: 3times/direction, total 18times. 4.Direction: ±X, ±Y, ±Z axis.	The appearance of the sample was normal.	Pass
3	Bump test	1.Acceleration: 10g; 2.Duration: 16ms; 3.Number: 1000 times/direction; 4.Direction: ±X, ±Y, ±Z axis.	The appearance of the sample was normal.	Pass
4	Seismic test	1.Frequency: 1~35Hz; 2.Cross-over Frequency: 8~9Hz; 3.Horizontal (X, Y) : Peak Displacement: 3.5mm; Acceleration: 1.0g; 4.Vertical (Z) : Peak Displacement: 1.5mm; Acceleration:0.5g; 5.Cycle Time: 10min /axis; 6.Direction: X, Y, Z axis.	The appearance of the sample was normal.	Pass

### Remark:

The tests were performed on model SOFAR 20000TL-Sx and the test result are also applicable for all other models stated in this report due to they have same hardware and construction enclosure.

IEC 60255-27			
Clause	Requirement + Test	Result - Remark	Verdict



LCJC-JL-708-02 A/0

**3. TEST SAMPLE PICTURES**

Sample picture before test



Test picture of Z-axis



15112019040615 / 1533



IEC 60255-27			
Clause	Requirement + Test	Result - Remark	Verdict



LCJC-JL-708-02 A/0

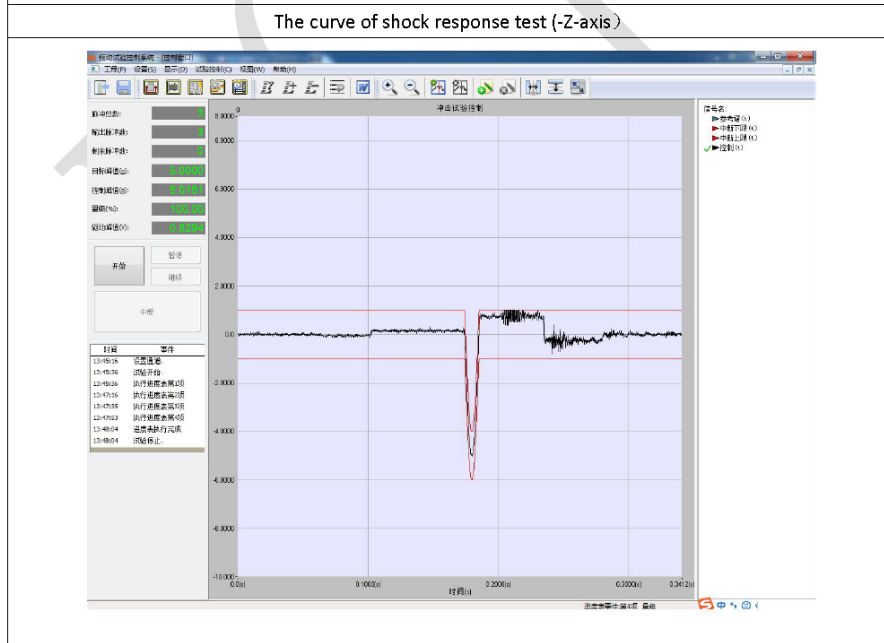
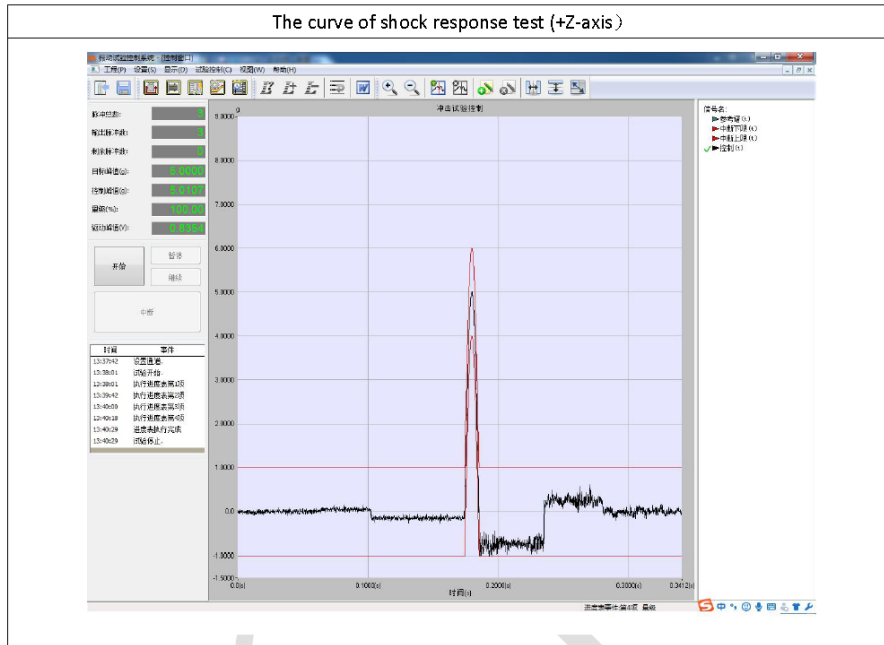

IEC 60255-27			
Clause	Requirement + Test	Result - Remark	Verdict



LCJC-JL-708-02 A/0

The curve of shock withstand test (+Z-axis)

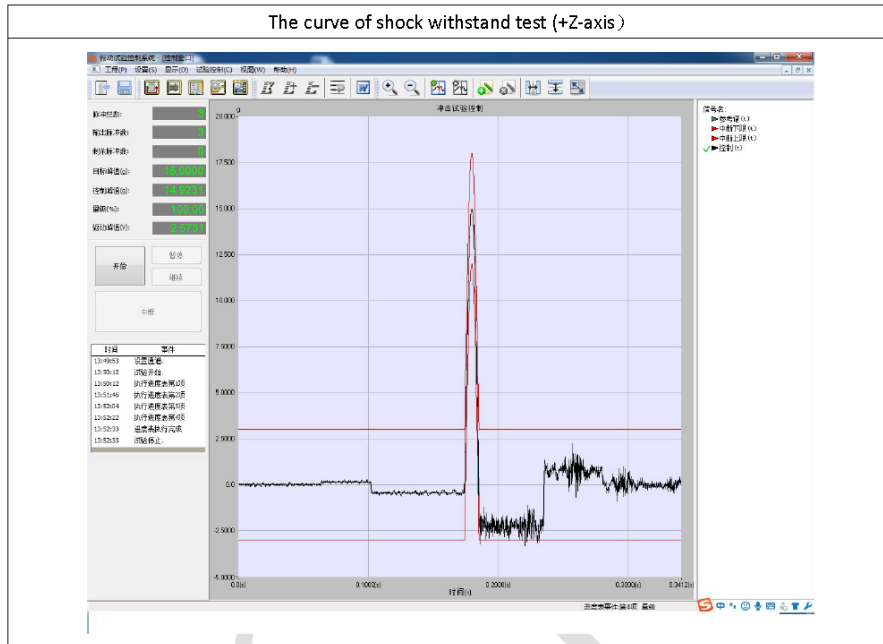

The curve of shock withstand test (-Z-axis)

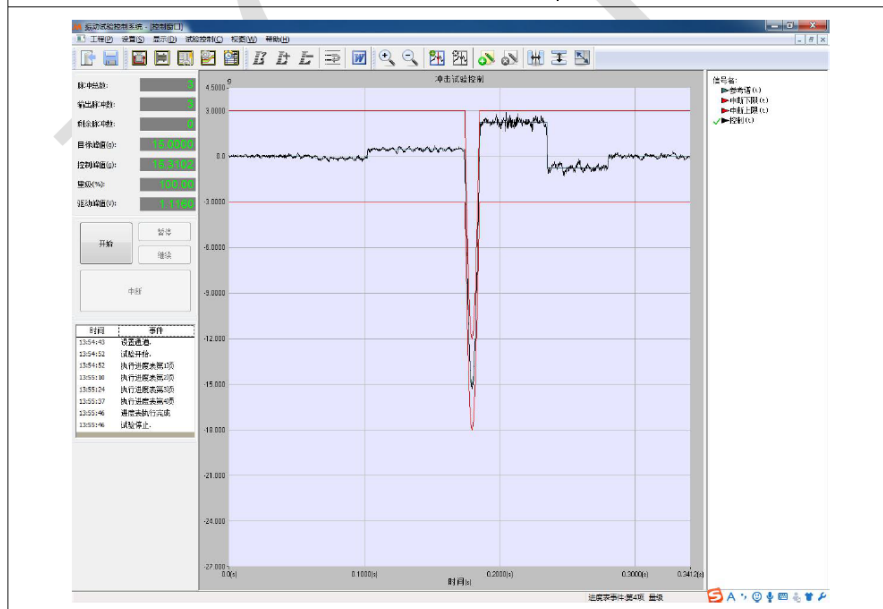

IEC 60255-27			
Clause	Requirement + Test	Result - Remark	Verdict



LCJC-JL-708-02 A/0

The curves of bump test (+Z-axis)

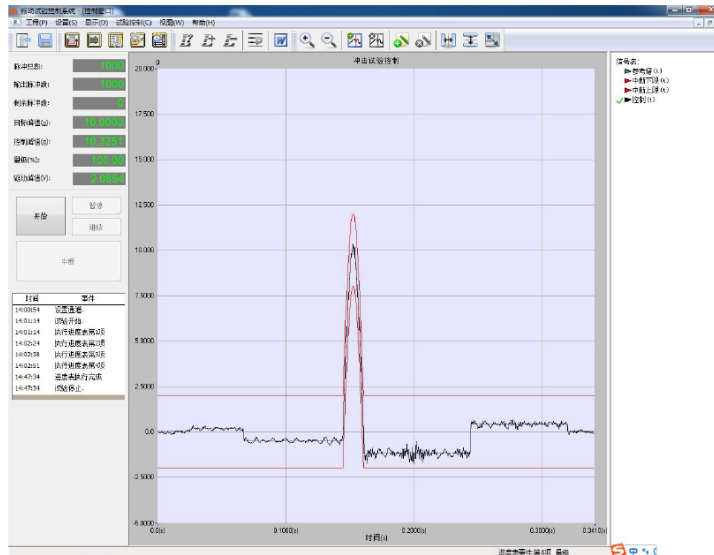

The curves of bump test (-Z-axis)

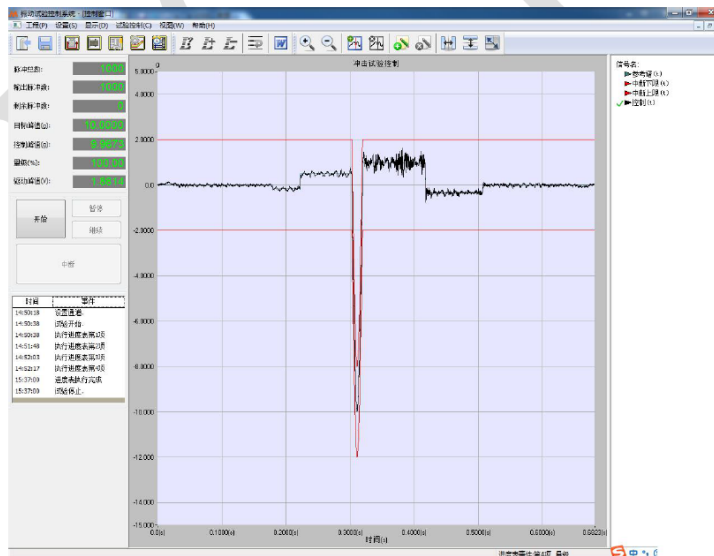

IEC 60255-27			
Clause	Requirement + Test	Result - Remark	Verdict



LCJC-JL-708-02 A/0

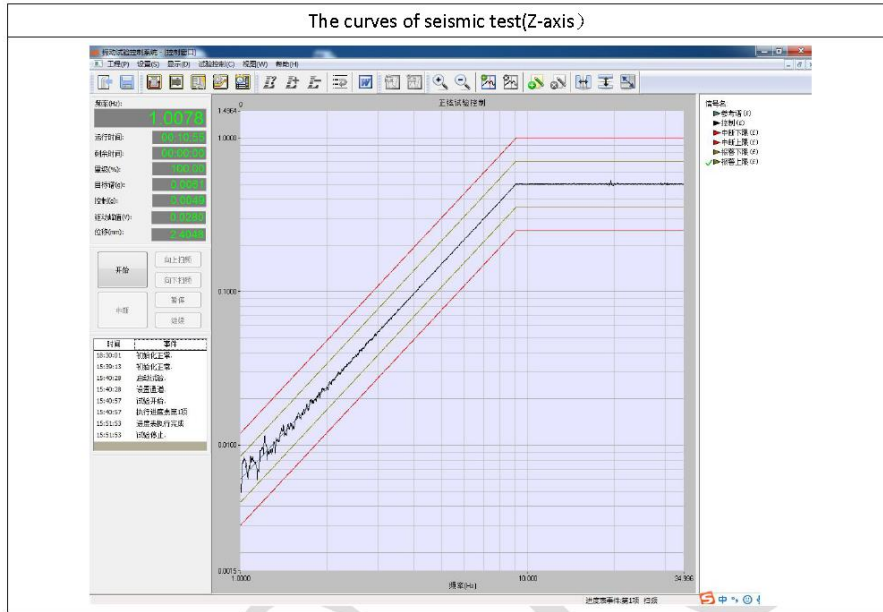

龙测测试



IEC 60255-27			
Clause	Requirement + Test	Result - Remark	Verdict



LCJC-JL-708-02 A/0

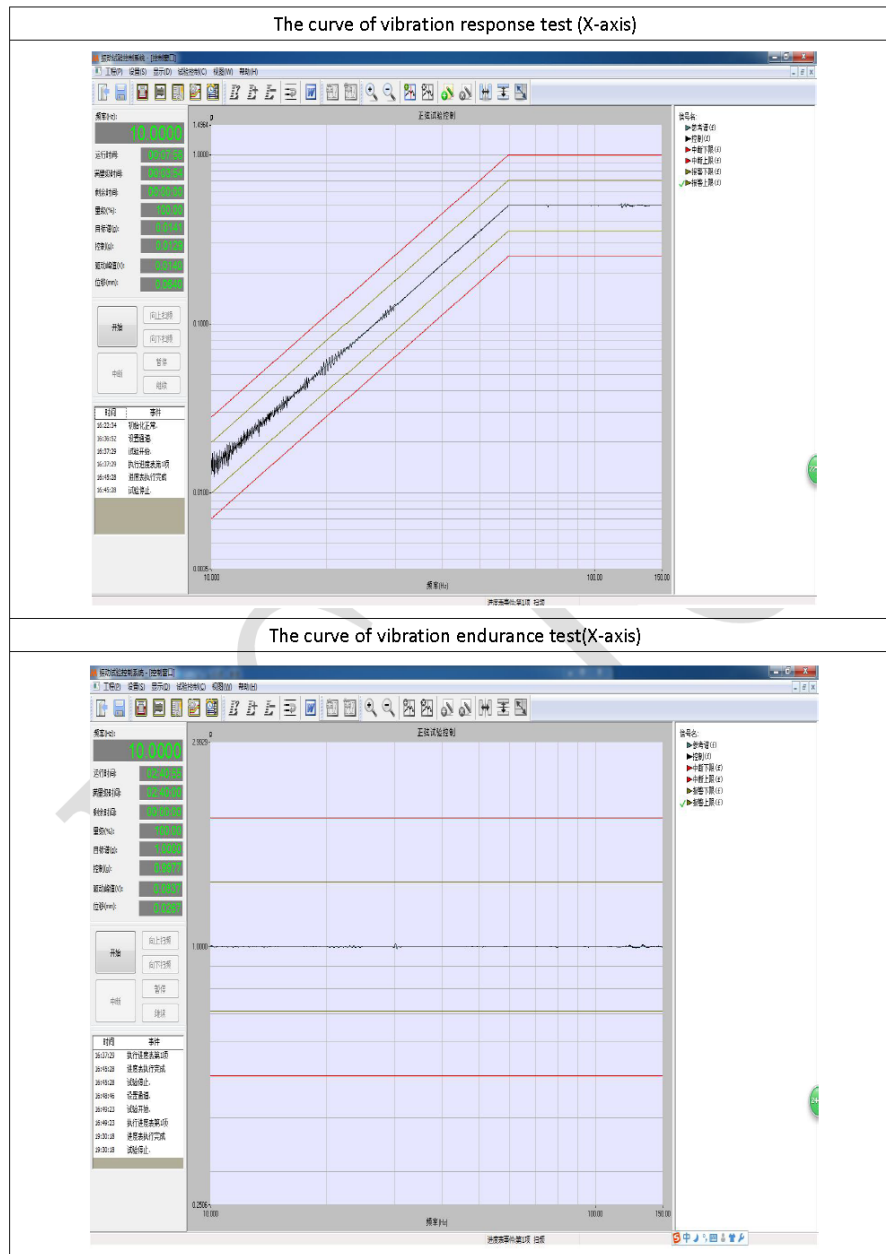

1. 龙测检测

IEC 60255-27			
Clause	Requirement + Test	Result - Remark	Verdict



LCJC-JL-708-02 A/0

The curve of shock response test (+X-axis)

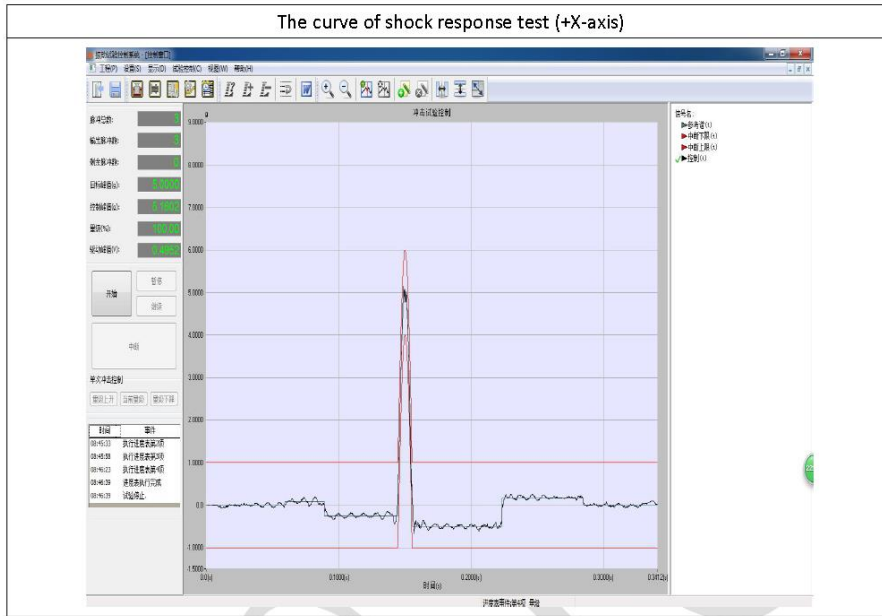

The curve of shock response test (-X-axis)

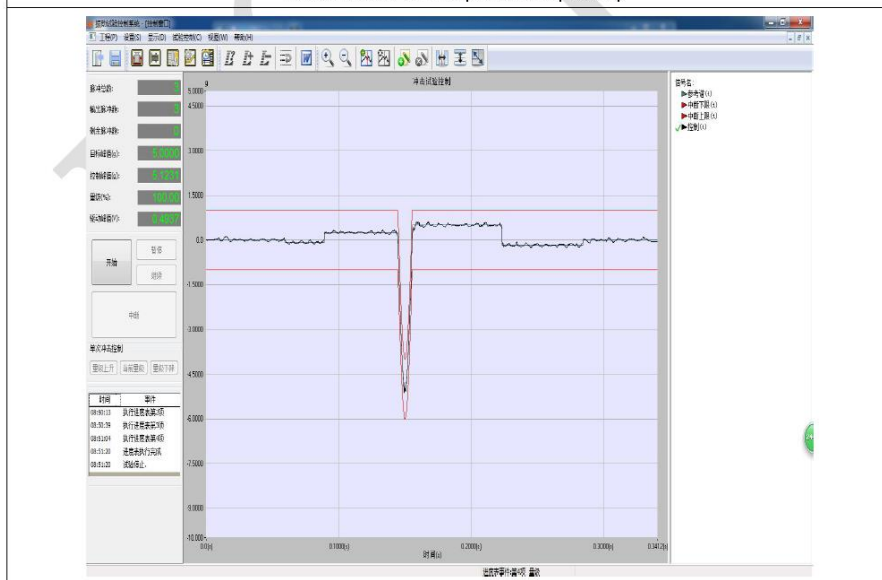

IEC 60255-27			
Clause	Requirement + Test	Result - Remark	Verdict



LCJC-JL-708-02 A/0

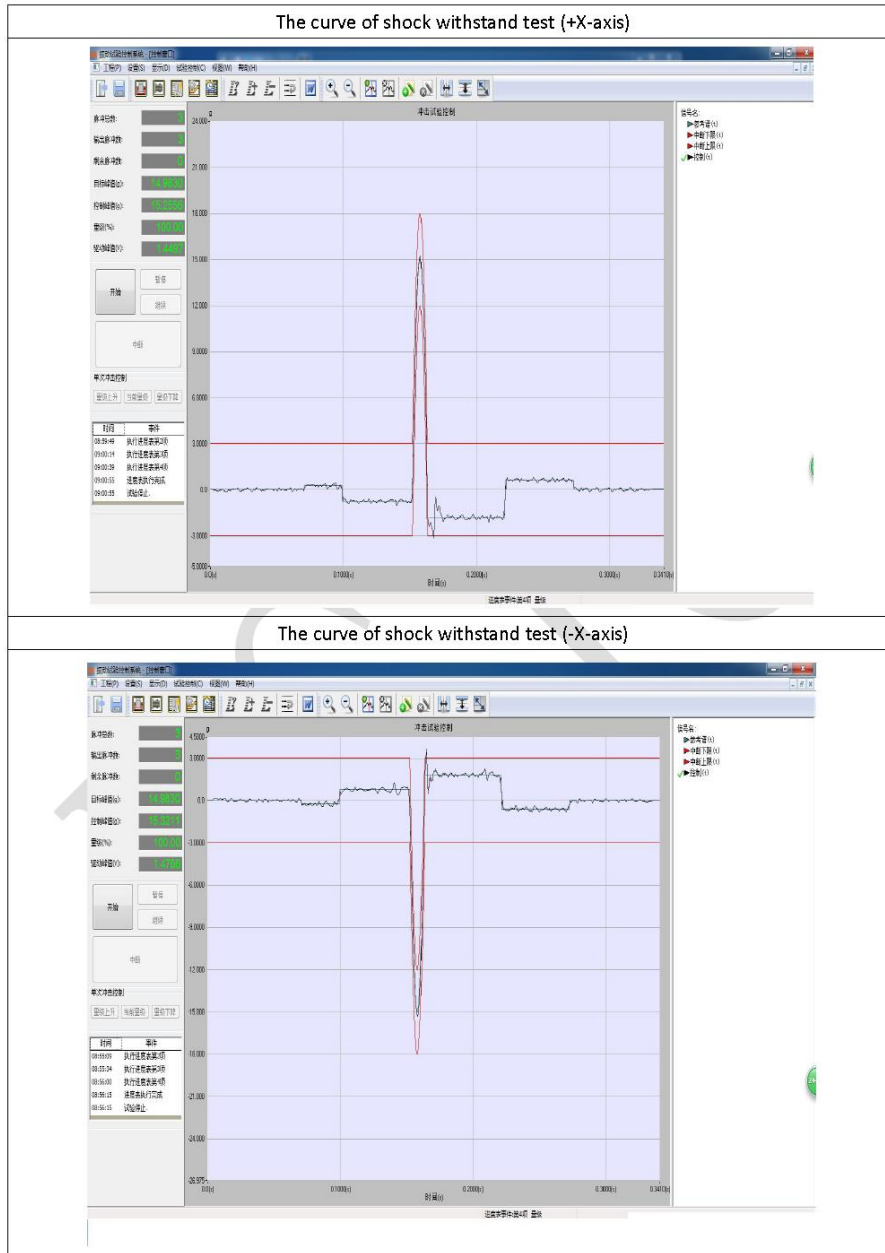

IEC 60255-27			
Clause	Requirement + Test	Result - Remark	Verdict



LCJC-JL-708-02 A/0

The curves of bump test (+X-axis)

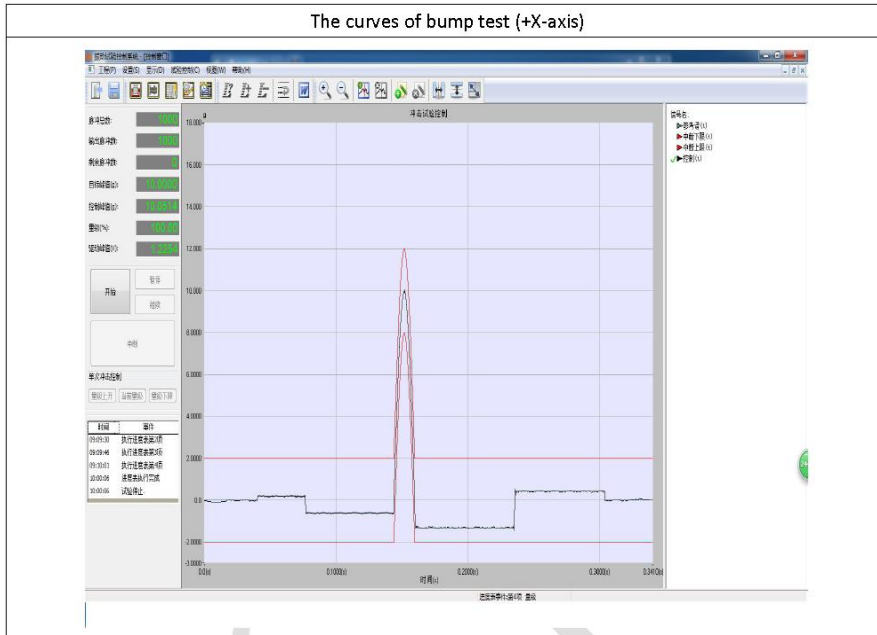

The curves of bump test (-X-axis)

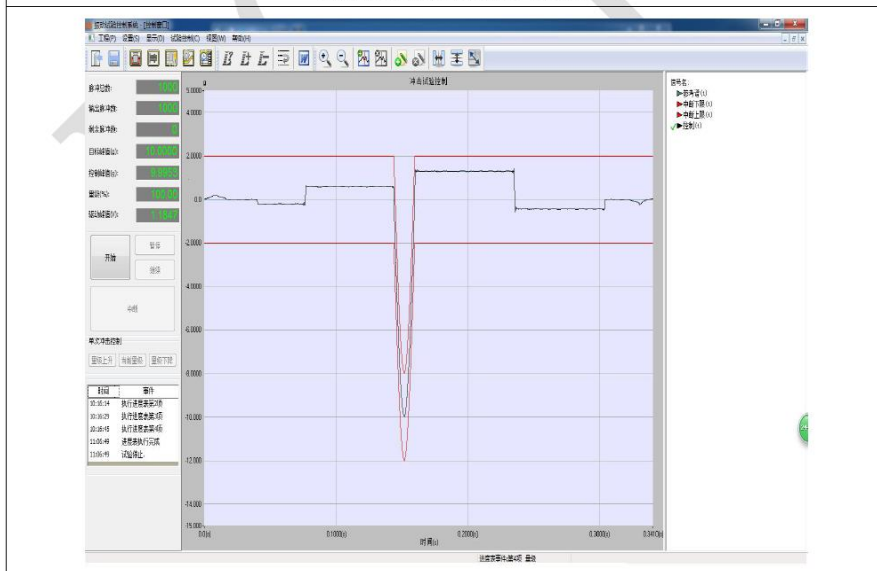

Suzhou Longce Testing Technology Service Co., Ltd.

IEC 60255-27			
Clause	Requirement + Test	Result - Remark	Verdict



LCJC-JL-708-02 A/0

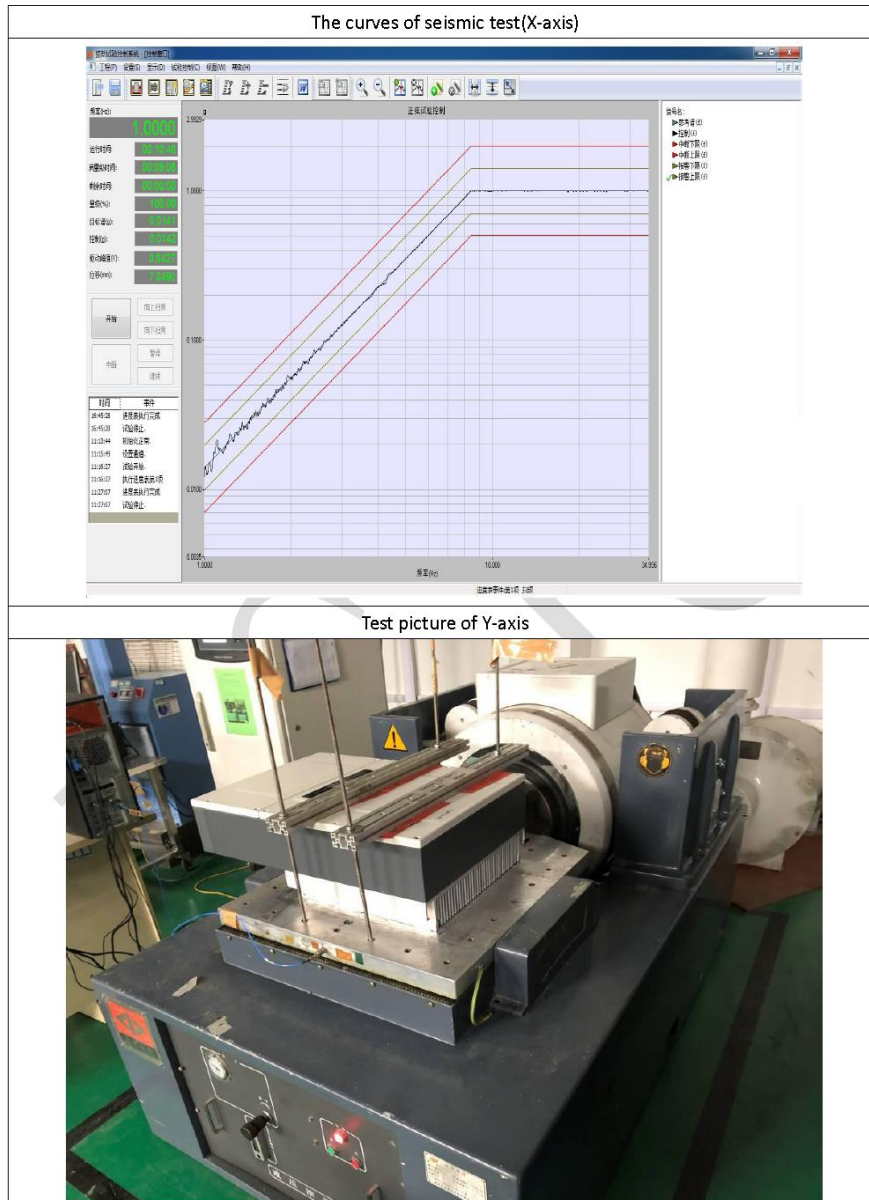

苏州龙测

IEC 60255-27			
Clause	Requirement + Test	Result - Remark	Verdict



LCJC-JL-708-02 A/0

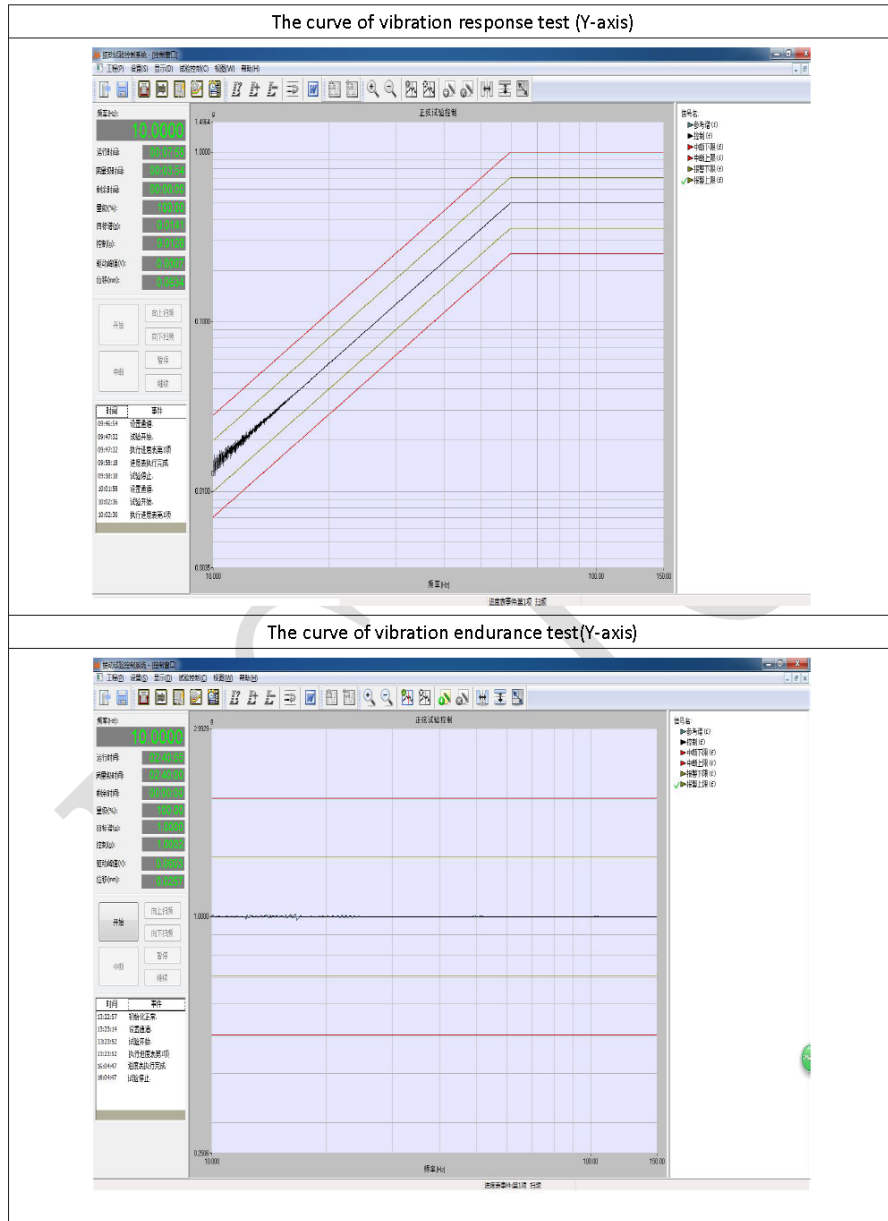

1.27.2024. 3:41 / 1



IEC 60255-27			
Clause	Requirement + Test	Result - Remark	Verdict



LCJC-JL-708-02 A/0

The curve of shock withstand test (+Y-axis)

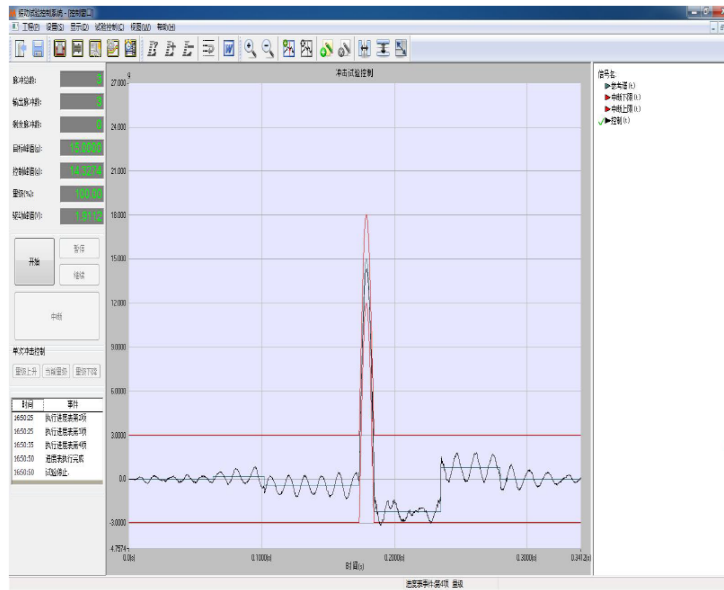

The curve of shock withstand test (-Y-axis)

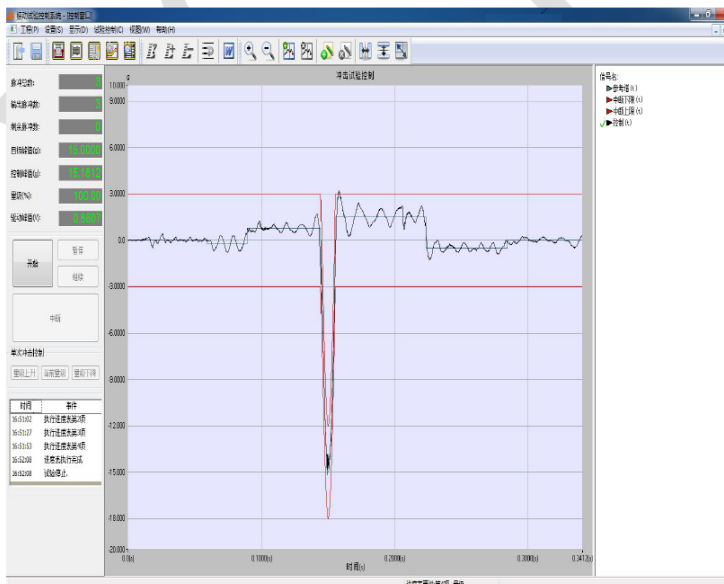

XIN



IEC 60255-27			
Clause	Requirement + Test	Result - Remark	Verdict



LCJC-JL-708-02 A/0

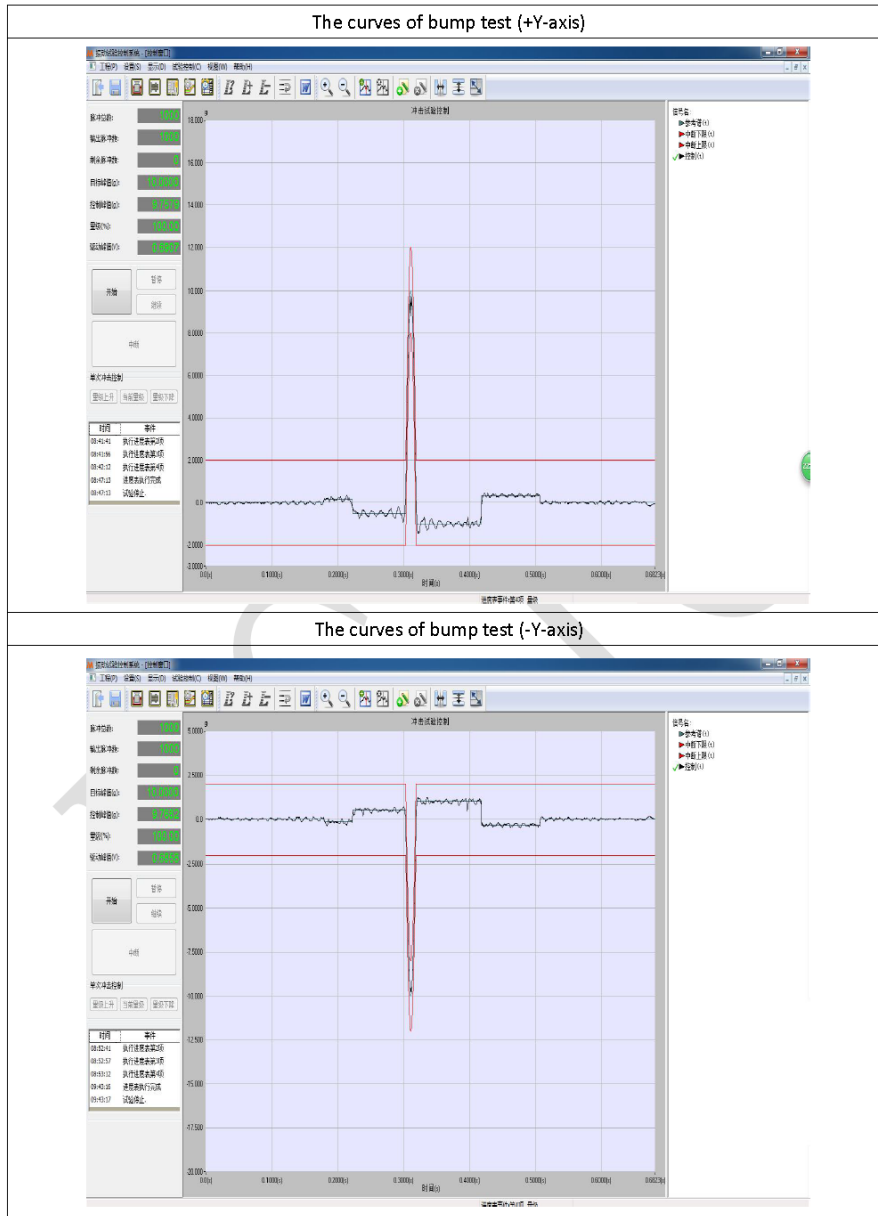

11月15日

IEC 60255-27			
Clause	Requirement + Test	Result - Remark	Verdict



LCJC-JL-708-02 A/0

The curves of seismic test(Y-axis)

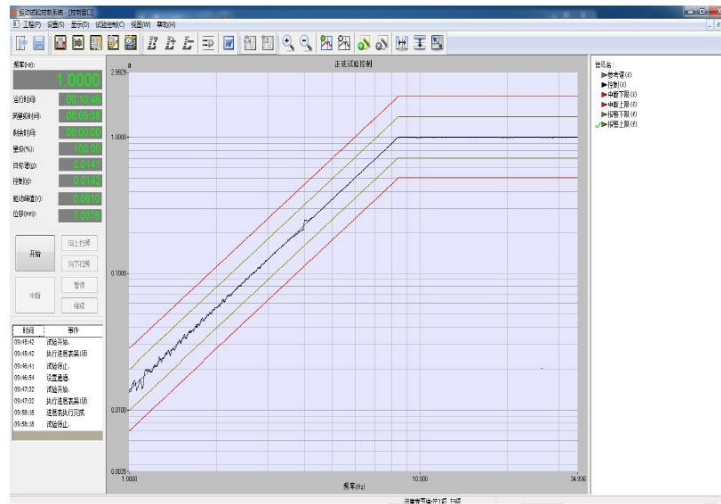

Sample picture after test



IEC 60255-27			
Clause	Requirement + Test	Result - Remark	Verdict



LCJC-JL-708-02 A/0



**4、TEST EQUIPMENT**

No.	Equipment Name	Model	Calibration Due Date
1	Vibration test equipment	ES-20-320	Mar. 18, 2020
2	Vibration test equipment	DC-4000-40	Mar. 18, 2020

Handwritten signature or mark

IEC 60255-27			
Clause	Requirement + Test	Result - Remark	Verdict



LCJC-JL-708-02 A/0

### Declaration

- 1、 The LAB have meet the required of CNAS-CL01:2018(Same as ISO/IEC 17025:2017), and have get the authorize from CNAS, CNAS Number: CNAS L8212, Also get the authorize from ISTA, ISTA ID: 10764;
- 2、 The LAB is responsible for the impartiality of all test data and the confidentiality of client information except the customer disclosure;
- 3、 The LAB is only responsible for the test items entrusted by the client;
- 4、 This report is valid in the condition of having sign of approver, special seal of laboratory testing and Connective seal, The report shall not be partial duplicated without written approval from the LAB except fully copy.
- 5、 The Samples were provided by the client, and the authenticity also is borne by the client, the LAB is only responsible for the test data of the sample;
- 6、 If have any objection to the report, please submit it to the LAB in writing within 15 days after receiving the report;
- 7、 The samples must be take back within 3 months,and the LAB will dispose it after the deadline.
- 8、 Subcontractor and Details: NA;
- 9、 The visual inspection used in this test is visual observation, except for non-visual observation.
- 10、 Conclusion language description:
  - (1) Pass : the samples conform to the requirements of the standard;
  - (2) Fail: the samples do not conform to the requirements of the standard ;
  - (3) / : don't judge or no test standard.
- 11、 Disclaimer: The Verdict of the report is only responsible for the appearance, and LAB shall not bear any risk responsibility for the performance data or function data which were provide by client, such as test data, test result and judgment requirements and so on.

**LAB:** Suzhou Longce Testing Technology Service Co., Ltd.

**ADD:** ( Building 5, National Environmental New & Hi-tech Industrial Park) No.369, Lushan Road,New District, Suzhou, China

**TEL:** 0512-68326317, 89990816

**FAX:** 0512-69200365

**E-mail:** lcjc@szlcjc.com

**\*\*\*End of the report\*\*\***

IEC 60255-27			
Clause	Requirement + Test	Result - Remark	Verdict

**Attachment 2: Pictures**

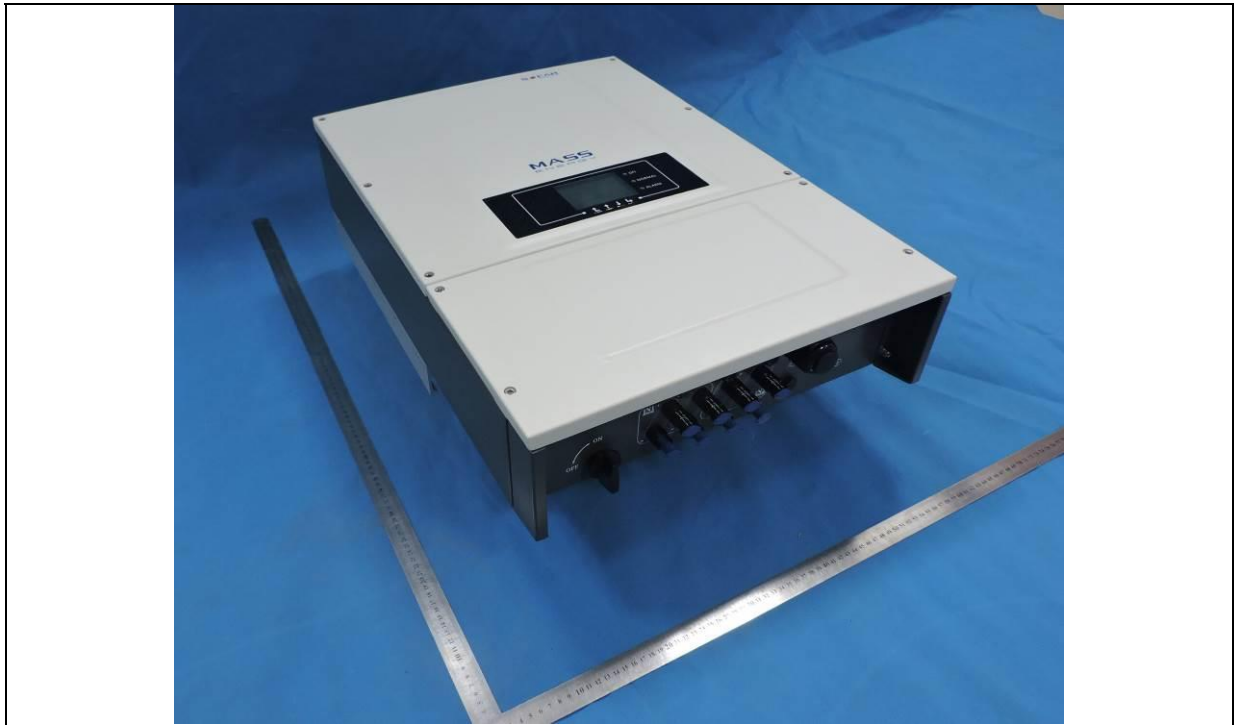

Enclosure – Front View

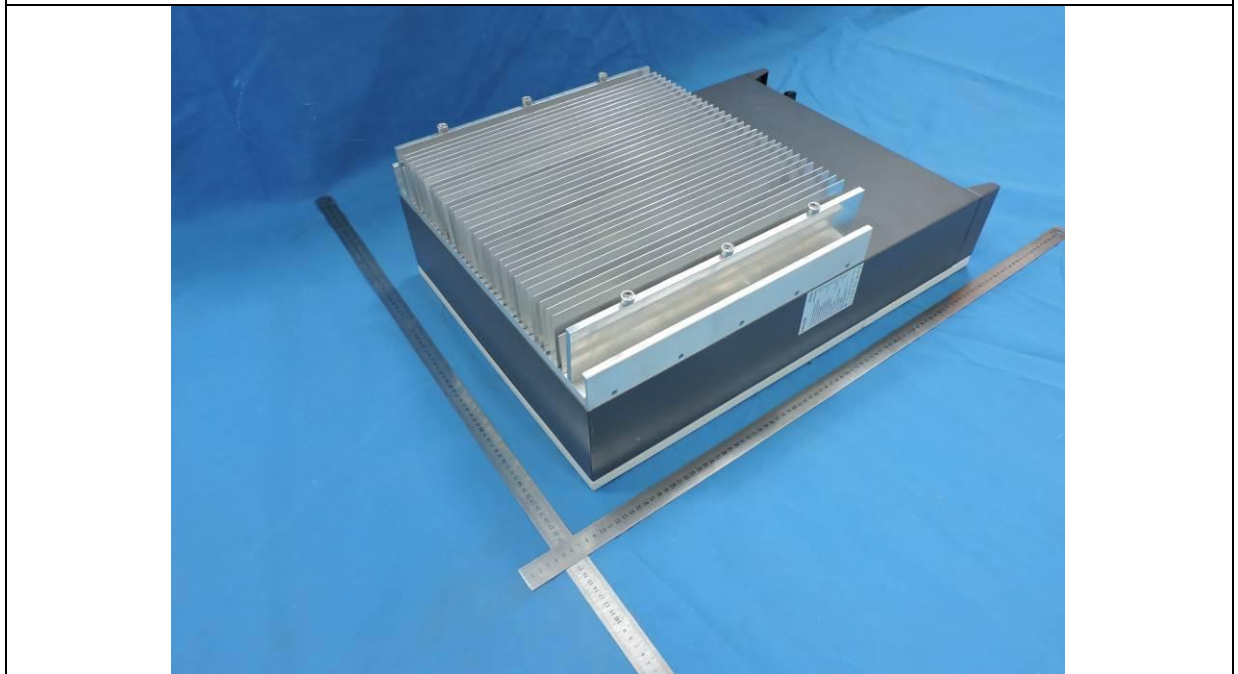

Enclosure – Rear View

IEC 60255-27			
Clause	Requirement + Test	Result - Remark	Verdict



Enclosure – Bottom View

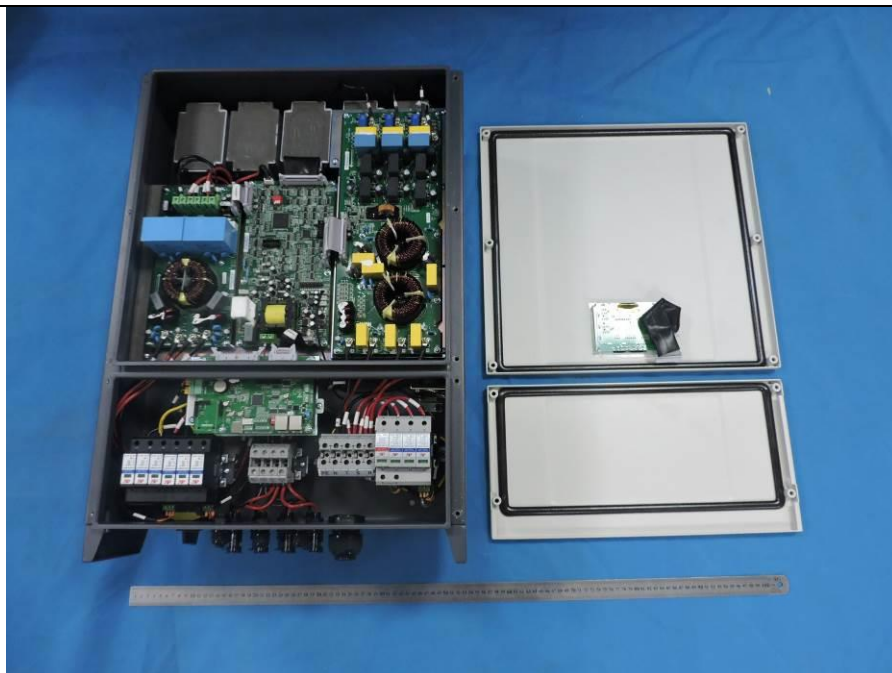

Internal View

IEC 60255-27			
Clause	Requirement + Test	Result - Remark	Verdict

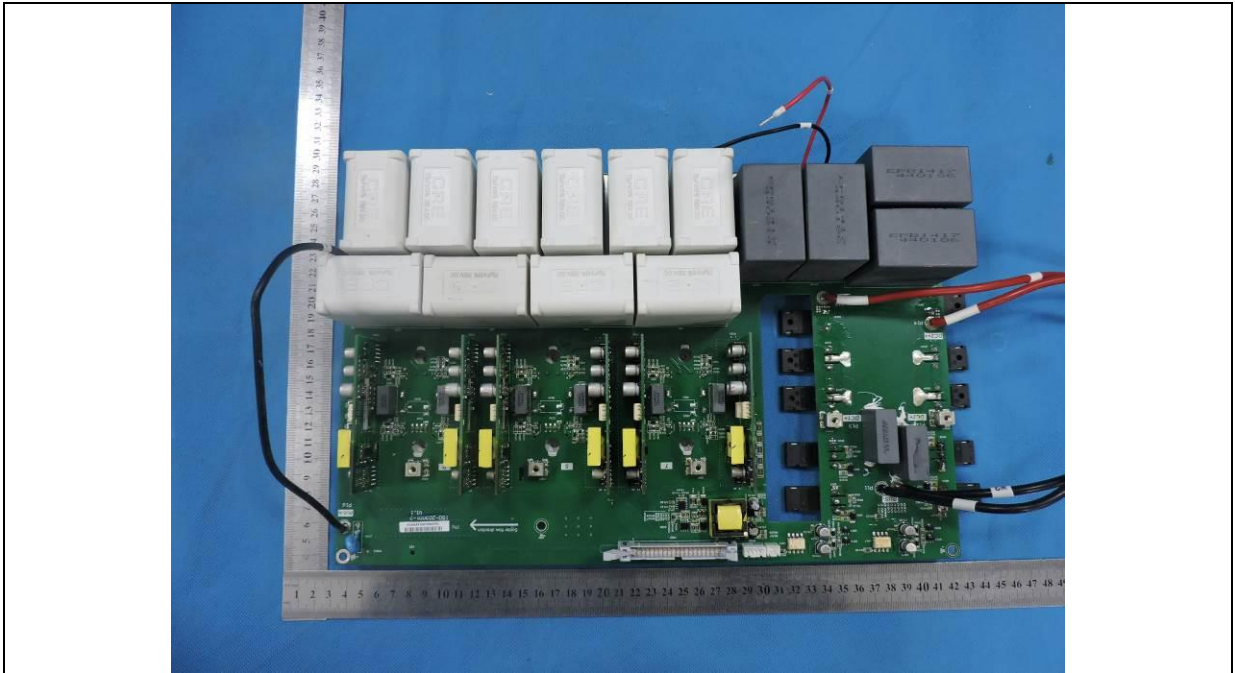

Main Board – Component Side

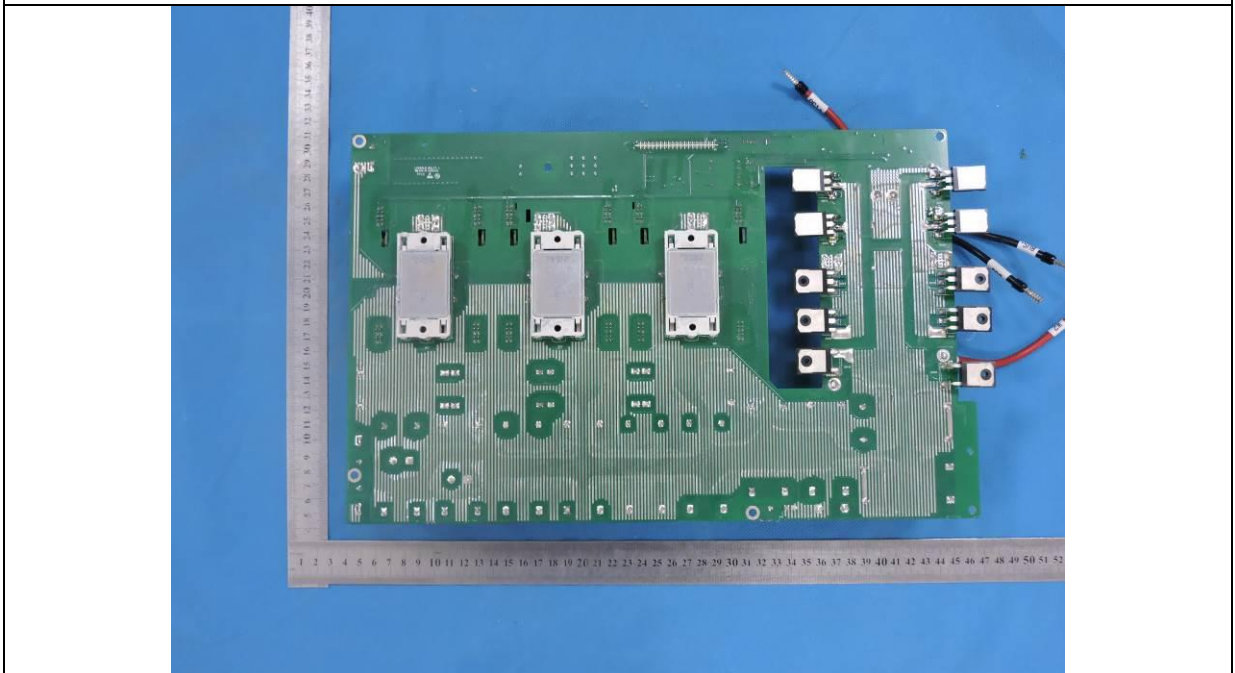

Main Board – Solder Side

IEC 60255-27			
Clause	Requirement + Test	Result - Remark	Verdict

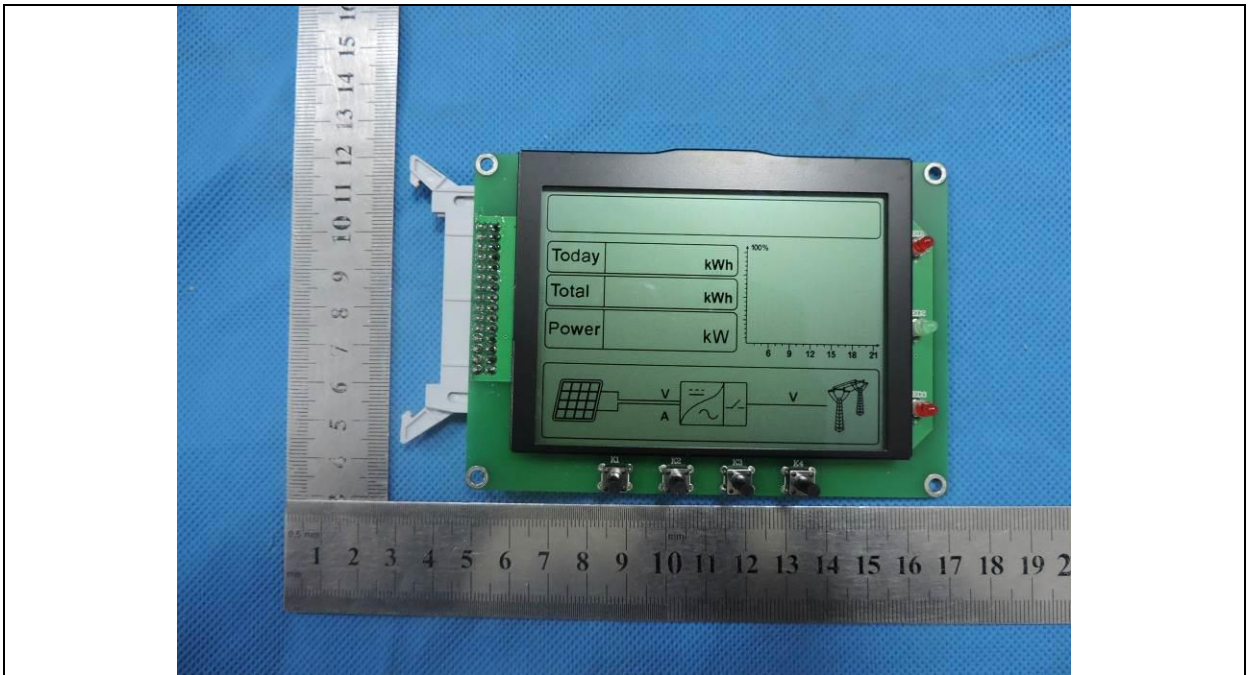

LCD Board – Component Side

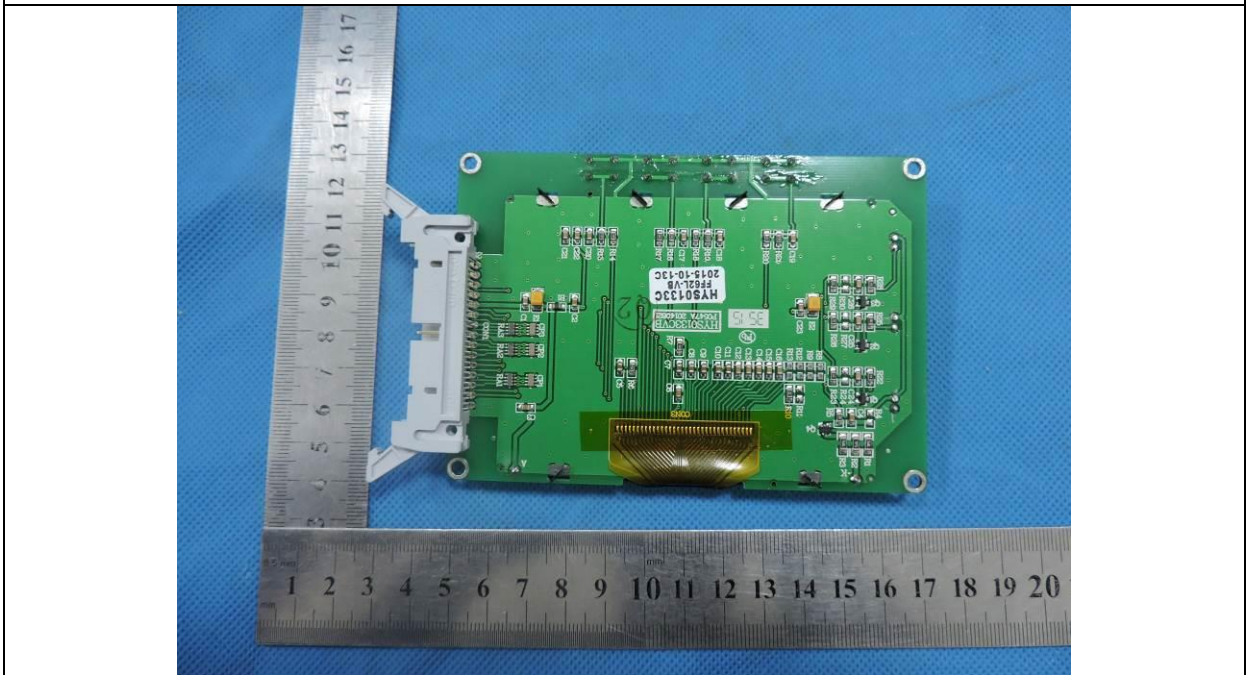

LCD Board – Solder Side



IEC 60255-27			
Clause	Requirement + Test	Result - Remark	Verdict

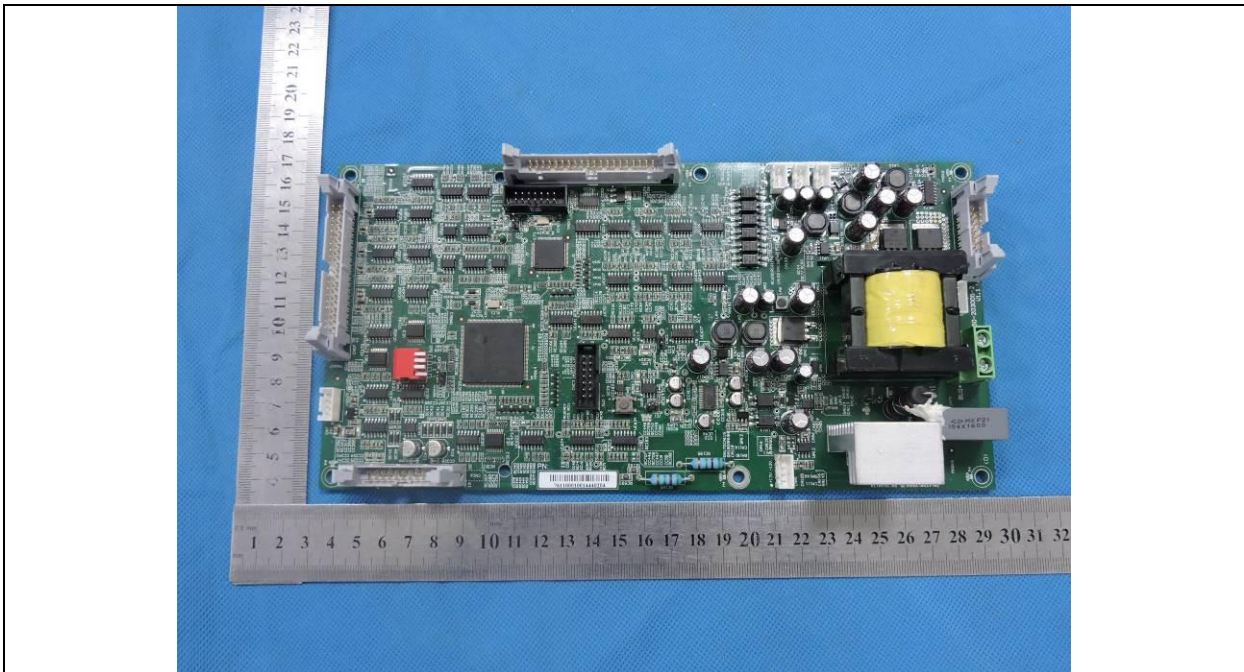

Control Board – Component Side

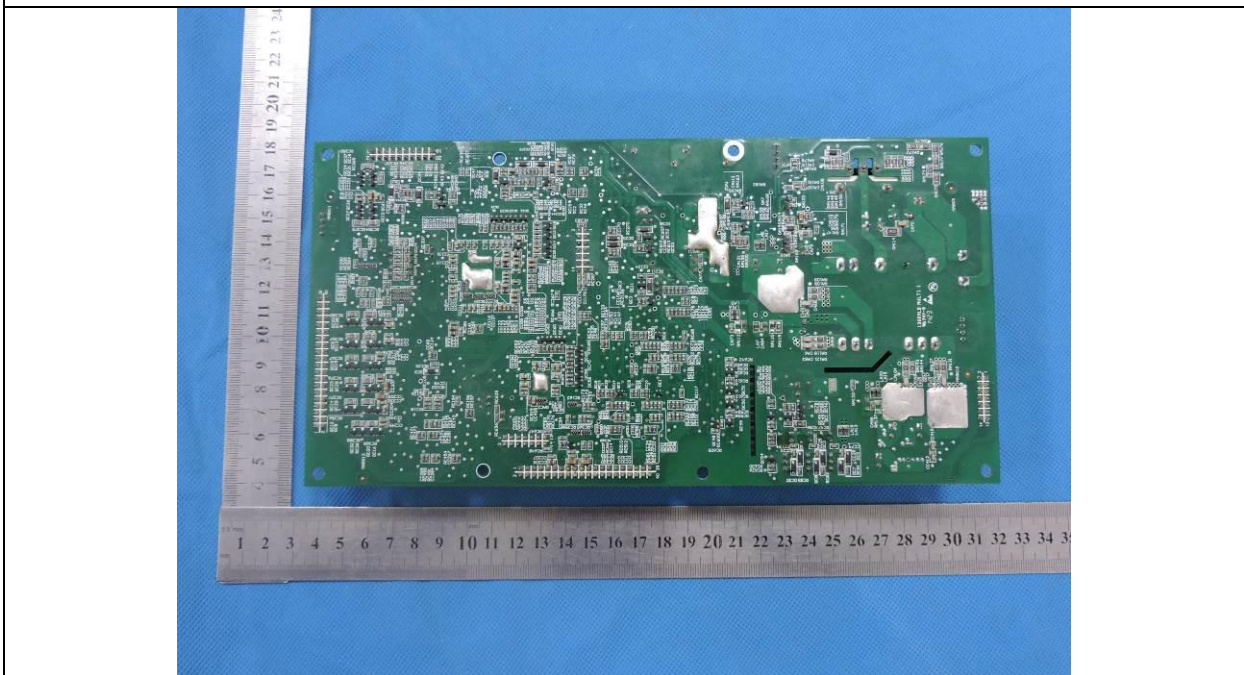

Control Board – Solder Side

IEC 60255-27			
Clause	Requirement + Test	Result - Remark	Verdict

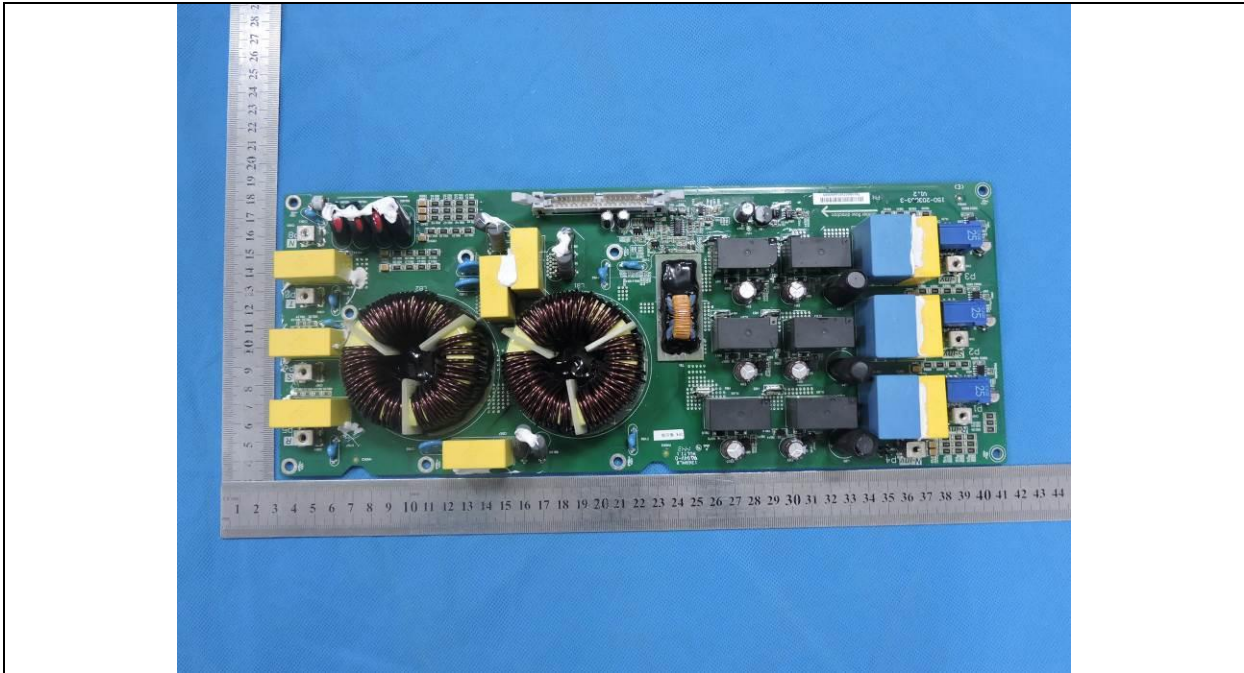

AC Output EMI Board – Component Side

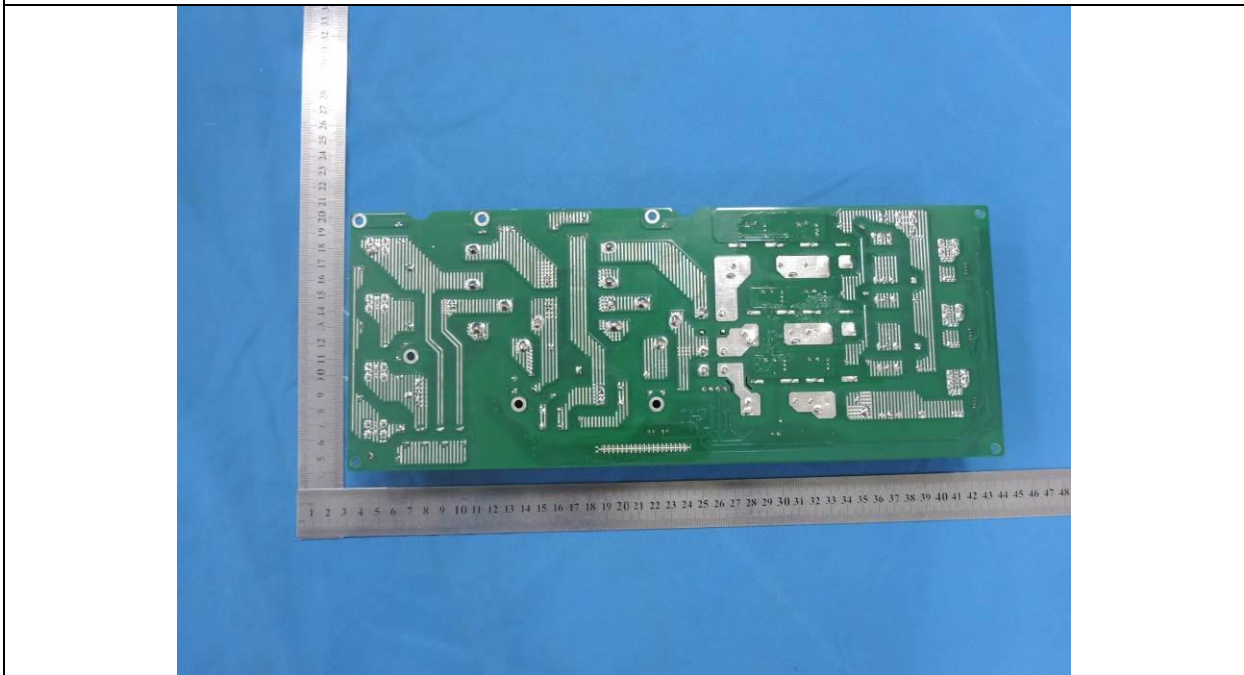

AC Output EMI Board – Solder Side

IEC 60255-27			
Clause	Requirement + Test	Result - Remark	Verdict

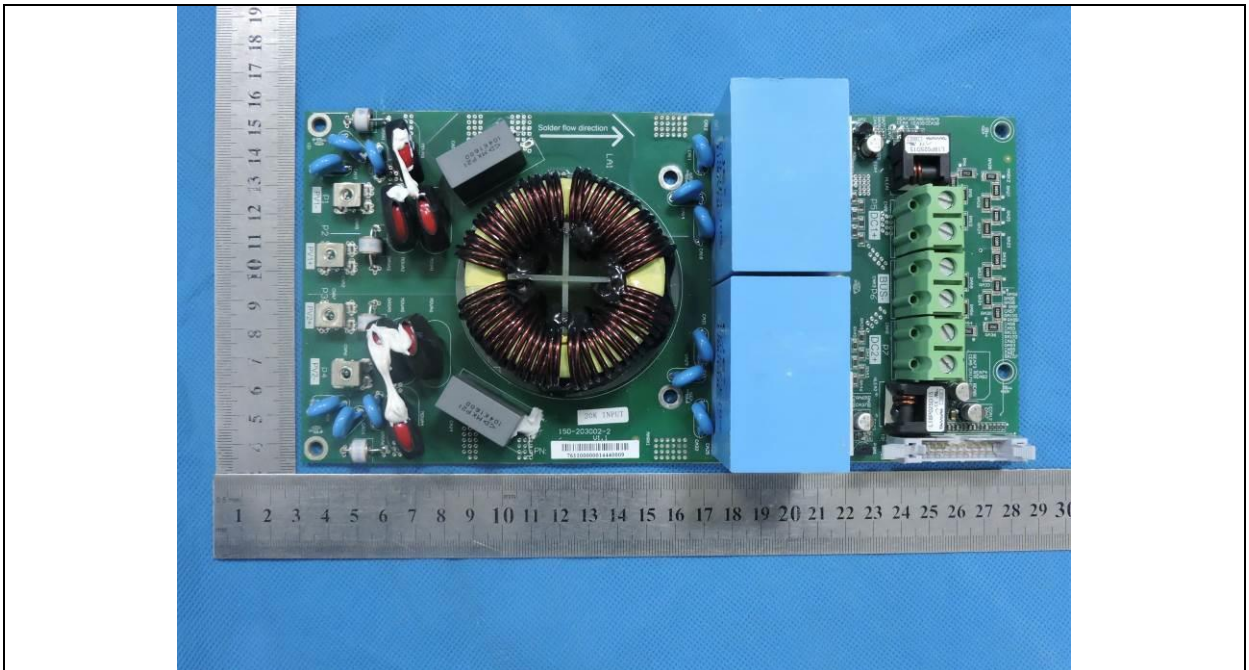

PV Input EMI Board – Component Side

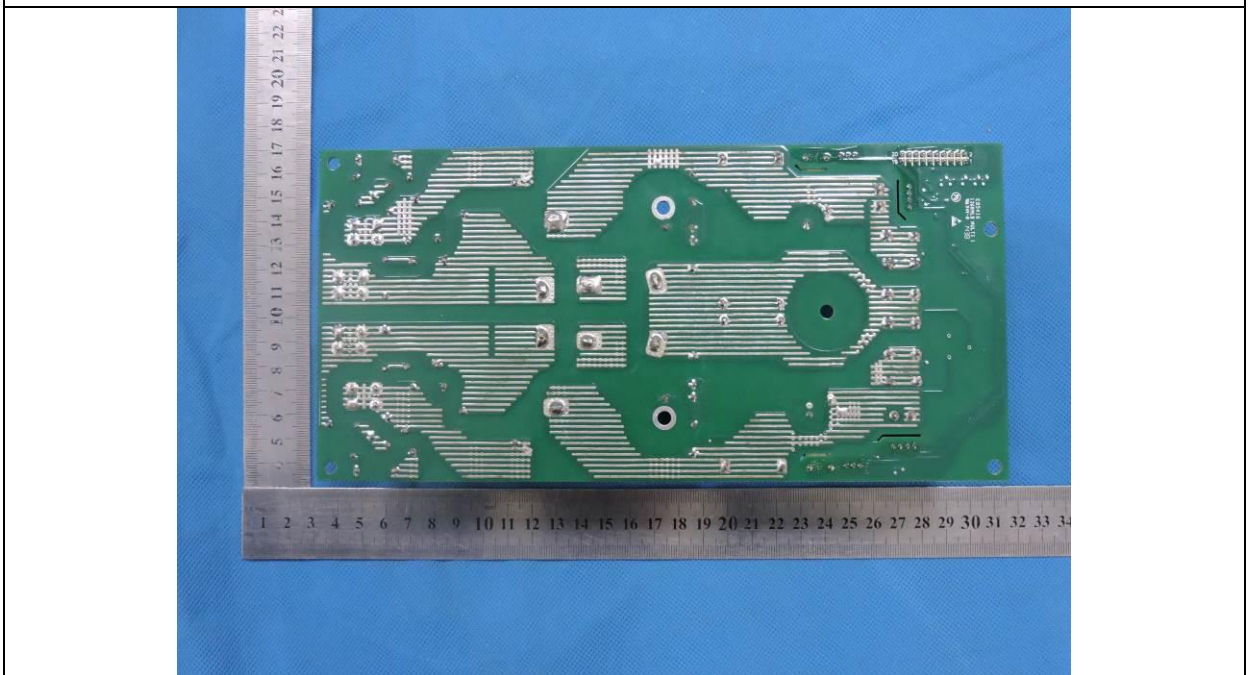

PV Input EMI Board – Solder Side

IEC 60255-27			
Clause	Requirement + Test	Result - Remark	Verdict

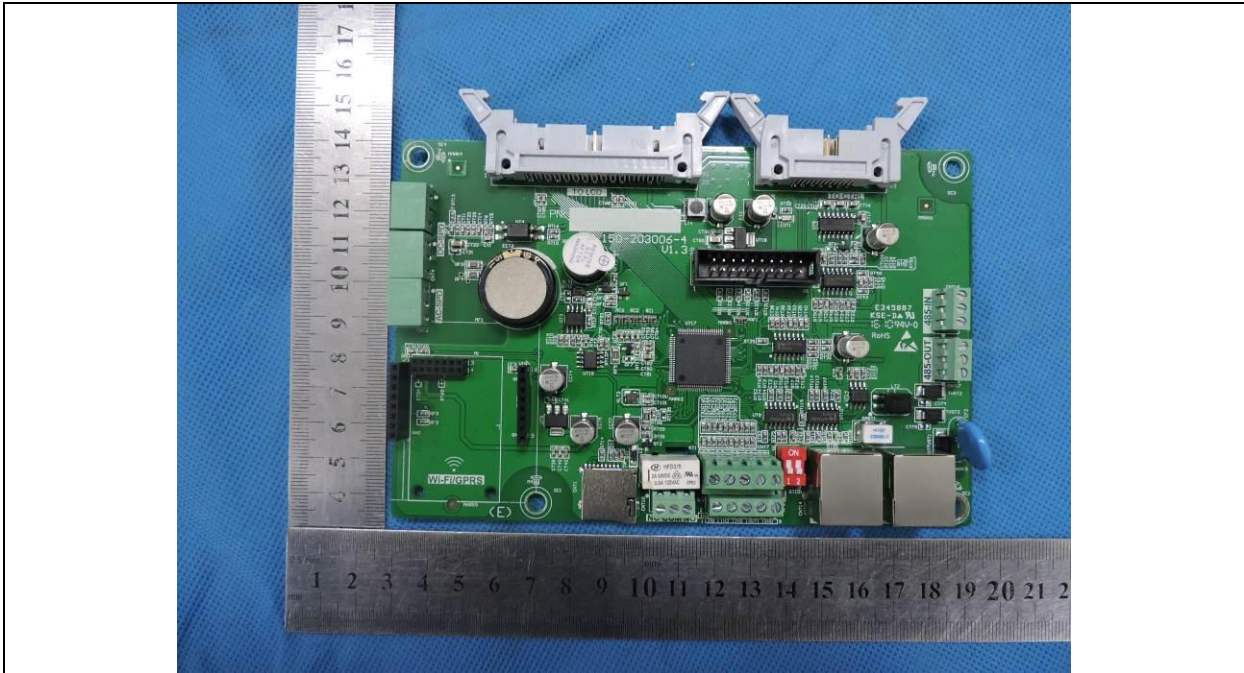

Communication Board – Component Side

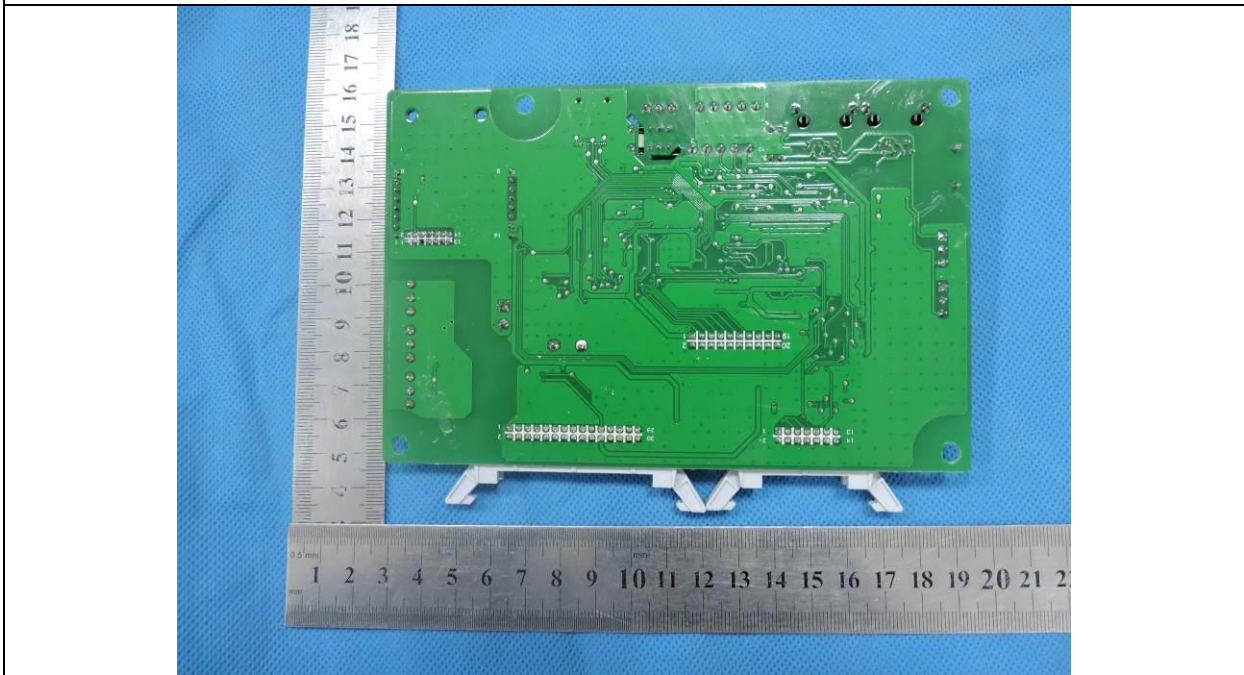

Communication Board – Solder Side

-----END-----